

Blue Smart IP22 Charger

12/15, 12/20, 12/30, 24/8, 24/12, 24/16 | (1) & (3)
Output | 230V

Table of Contents

1. Safety instructions	1
2. Quick start guide	2
3. Features	4
4. Operation	6
4.1. Charge algorithm	6
4.2. Charge modes	8
4.2.1. Charge voltage	8
4.2.2. Recondition mode	8
4.2.3. Low current mode	9
4.2.4. Night mode	9
4.3. Temperature compensation	10
4.4. VE.Smart networking	11
4.4.1. Voltage sense	11
4.4.2. Temperature sense	11
4.4.3. Current sense	12
4.4.4. Synchronised charging	12
4.5. Commencing a new charge cycle	13
4.6. Estimating charge time	14
4.6.1. Lead-acid based chemistry	14
4.6.2. Li-ion based chemistry	14
4.7. Multiple isolated outputs	15
5. Installation	16
5.1. Mounting	16
5.2. Wiring	17
5.2.1. DC power cable	19
5.2.2. Overcurrent protection	22
5.3. Schematics	23
5.3.1. Basic install	23
5.3.2. System with Smart Battery Sense	25
5.3.3. System with SmartShunt	27
5.3.4. System with multiple chargers	29
6. Setup	30
6.1. Setup using the charger	30
6.2. Setup using VictronConnect	31
6.3. Bluetooth	35
6.3.1. Changing the PIN code	35
6.3.2. Resetting the PIN code	38
6.3.3. Disabling Bluetooth	41
6.3.4. Re-enabling Bluetooth	43
6.4. Updating firmware	44
6.4.1. Automated firmware update	44
6.4.2. Manual firmware update	48
6.5. Reset to defaults	53
7. Monitoring	55
7.1. LED indications	55
7.1.1. Operation states	55
7.2. VictronConnect	56
7.2.1. Status screen	56
7.2.2. Graph screen	57
7.2.3. History screen	58
7.3. Instant readout	60
8. Advanced Configuration	64
8.1. Advanced settings	64
8.2. Expert mode settings	68

8.3. VE.Smart Networking	71
8.3.1. Voltage, temperature and current sense	71
8.3.2. Synchronised charging	76
8.4. Power supply mode	80
9. Technical specifications	82
10. Warranty	83

1. Safety instructions



WARNING: CAREFULLY READ AND FOLLOW ALL SAFETY INSTRUCTIONS

- Carefully read the manual **before** the charger is installed and operated; retain the manual in a safe place for future reference.
- The charger must **not** be installed or operated by anyone who lacks the appropriate knowledge or competence required for safe installation and/or usage.
- **Charger installation and operation**
 - A. Install the charger in a location with good natural airflow/ventilation and sufficient unobstructed space around it; refer to the the 'Installation > Mounting' section for more information.
 - B. Install the charger on a non-flammable substrate and ensure there are no heat-sensitive items in the immediate vicinity; it is normal for the charger to become hot during operation.
 - C. Install the charger in a location where it is protected from environmental conditions such as water, moisture, dust and direct sunlight.
 - D. Do not install or operate the charger directly above the battery, or in a sealed compartment with the battery; batteries can emit explosive gasses.
 - E. Do not cover or place any other items on top of the charger.
- **Battery installation and charging**
 - A. Install and charge the battery in a location with good natural airflow/ventilation.
 - B. Ensure that there are no ignition sources near the battery; batteries can emit explosive gasses.
 - C. Battery acid is corrosive; if battery acid comes into contact with skin immediately rinse with water.
 - D. Do not charge non-rechargeable batteries or Li-ion batteries if the battery temperature is below 0°C.
- **DC connection to battery**
 - A. Use flexible multi stranded copper DC power cable with sufficient cross sectional area, and install a suitably rated inline fuse or circuit breaker located as close as practical to the battery; refer to the 'Installation > Wiring' section for more information.
 - B. Ensure that the DC power cable polarity is correct at all connections.
 - C. Ensure that the DC system is fully shut down/isolated prior to disconnection of any existing cabling and/or new connections are made to the battery/DC system.
 - D. There are specific wiring connection instructions for charging a battery installed within a vehicle; refer to the 'Installation > Wiring' section for more information.
- **AC connection to mains supply**
 - A. AC connection to the mains supply must be in accordance with local electrical regulations. The charger must be plugged into an earthed AC mains power outlet.
 - B. Do not operate the charger if the AC power cable is damaged, contact a service agent.
- **Charger setup**
 - A. Refer to the battery manufacturers instructions and specifications to ensure the battery is suitable for use with this charger and confirm the recommended charge settings.
 - B. The integrated charge modes (selected via the charger or Bluetooth) combined with adaptive charge logic are well suited for most common battery types; such as flooded lead-acid, AGM, Gel and LiFePO4.

If necessary, advanced configuration with user defined settings is also possible using a Bluetooth enabled device (mobile phone or tablet) with the **VictronConnect** app.

2. Quick start guide

1. The **Blue Smart IP22 Charger** range is designed to be permanently mounted using the mounting tabs on the base of the charger.

Identify/provide a suitable and safe location for the charger on a non-flammable substrate, with at least 10cm of clearance surrounding the charger and good natural airflow/ventilation; do not install or place/operate the charger on top of the battery, directly above the battery, or in a sealed compartment with the battery.

Mount the **Blue Smart IP22 Charger** vertically with the terminals facing down; secure using suitable pan/flange head screws through the mounting holes/slots.

2. Remove the terminal cover, then connect suitable DC power cabling between the **Blue Smart IP22 Chargers** BATTERY terminals (torque the terminal screws to 2.4Nm and reinstall the terminal cover) and the battery or DC system distribution bus.

There are specific wiring connection instructions for charging a battery installed within a vehicle; refer to the 'Installation > Wiring' section for more information.

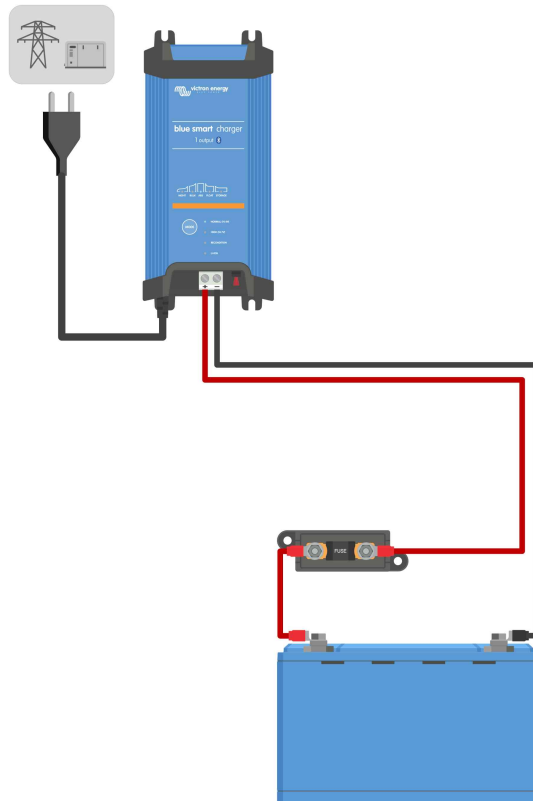

3. Connect the **Blue Smart IP22 Charger** AC power cable to a mains power outlet; after a short delay the LEDs indicating the current charge mode and charge state will illuminate.

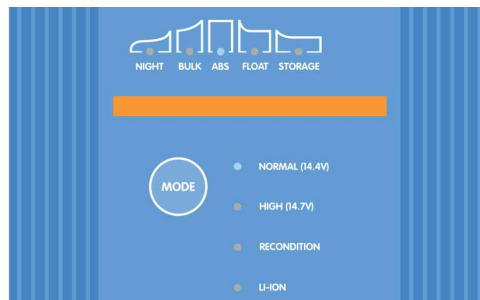

4. Select the charge mode and charge current limit most appropriate for the battery type and capacity.

To setup using the charger:

- A. Press (and release) the **MODE** button on the **Blue Smart IP22 Charger** to cycle through and select the most appropriate integrated charge mode (Normal, Normal + Recondition, High, High + Recondition or Li-ion).



- B. The LED beside the currently selected charge mode (NORMAL / HIGH / LI-ION) will be illuminated, as well as the RECONDITION LED if enabled.



- C. If the maximum rated charge current is excessive, enable low current mode; refer to the 'Setup > Setup using the charger' section for instructions.

To setup using VictronConnect:

- A. Using a Bluetooth enabled device (mobile phone or tablet), open the **VictronConnect** app and locate the **Blue Smart IP22 Charger** in the Device list Local page, then connect to the device (the default PIN code is stated on a label located on the back of the charger, or try 000000 if there is no label).
- B. Select the **Settings** icon (gear in the top right corner) to access the Settings page.
- C. Select the most appropriate integrated charge mode (Normal, Normal + Recondition, High, High + Recondition or Li-ion) from the Charge preset menu.

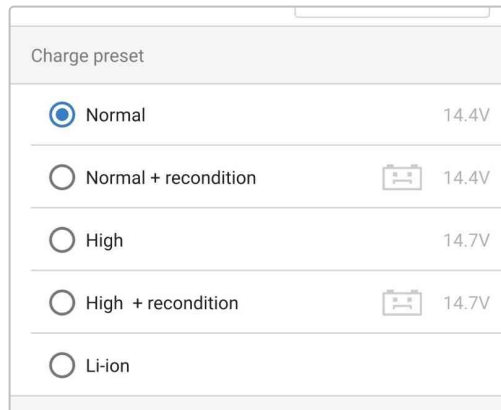

- D. If the maximum rated charge current is excessive, enable low current mode; refer to the 'Setup > Setup using VictronConnect' section for instructions.

All settings are stored and will not be lost when the charger is disconnected from mains power or the battery.

5. When the ABS LED is illuminated the charger has moved into absorption stage (bulk stage is complete); the battery will be approximately 80% charged (or >95% for Li-ion batteries) and may be returned into service if required.
6. When the FLOAT LED is illuminated the charger has moved into float stage (absorption stage is complete); the battery will be fully (100%) charged and is ready to be returned into service.
7. When the STORAGE LED is illuminated the charger has moved into storage mode (float stage is concluded); to maintain the battery at full charge, the battery can be left on continuous charge for an extended duration.
8. To stop charging disconnect the power supply to the AC power cable.

3. Features

A. Bluetooth setup and monitoring (Using VictronConnect)

Equipped with integrated Bluetooth; enabling quick and simple setup, advanced configuration, comprehensive monitoring and firmware updates via the **VictronConnect** app and a Bluetooth enabled device (mobile phone or tablet).

B. VE.Smart Network compatible

VE.Smart Networking capability allows multiple chargers to operate in unison with synchronised charging, and receive accurate battery voltage (Volt-sense), charge current (Current-sense) and battery temperature (Temp-sense) data from a compatible battery monitor (such as a BMV, SmartShunt, Smart Battery Sense or VE.Bus Smart Dongle) to further enhance the charge cycle.

C. Integrated charge presets

Integrated charge presets (selected via the **MODE** button or **VictronConnect** app) combined with adaptive charge logic are well suited for most common battery types; such as LiFePO₄, AGM, Gel and flooded lead-acid. Advanced configuration with specific user defined settings is also possible using **VictronConnect**.

D. Multi-stage charge algorithm

The multi-stage charge algorithm is specifically engineered to optimise each recharge cycle and charge maintenance over extended periods.

E. Adaptive absorption

Adaptive absorption monitors the battery's response during initial charging and intelligently determines the appropriate absorption duration for each individual charge cycle. This ensures that the battery is fully recharged regardless of the discharge level or capacity and avoids excessive time at the elevated absorption voltage (that can accelerate battery aging).

F. Temperature compensation

Charge voltage is automatically compensated depending on the ambient temperature; this ensures that the battery is charged at the optimal charge voltage regardless of the climate and avoids the need for manual settings adjustments. Temperature compensation is not required and automatically disabled when in LI-ION charge mode.

G. High efficiency

The **Blue Smart IP22 Charger** range is up to ~94% efficient; resulting in lower power usage, less heat generated and cooler operation

H. Durable and safe

Engineered to provide years of trouble-free and dependable operation in all usage conditions:

- i. Protection against overheating: Output current will be derated if the ambient temperature increases above 40°C (linear derate from 100% at 40°C to 25% at 50°C)
- ii. Protection against output short circuit: If a short circuit condition is detected the charger will shut down
- iii. Protection against reverse polarity connection: If the charger is incorrectly connected to a battery with reverse polarity the user replaceable fuse will blow

I. Silent operation

Charger operation is silent whilst the cooling fan is off; the cooling fan is only activated when it is necessary during demanding periods. If the NIGHT or LOW current mode is activated; the maximum output current is reduced to 50% of nominal and the cooling fan will remain off.

J. Lithium Ion compatible

Compatible with Li-ion (LiFePO₄) batteries; when the integrated LI-ION charge mode is selected the charge cycle settings are altered to suit.

If the charger is connected to a battery where under voltage protection (UVP) has tripped, it will automatically reset UVP and start charging; many other chargers will not recognise a battery in this state.

Warning: Do not charge Li-ion batteries if the battery temperature is below 0°C.

K. Storage stage

An additional stage to extend battery life whilst the battery is unused and on continuous charge.

L. Recondition stage

An optional stage that can partially recover/reverse lead acid battery degradation due to sulfation; typically caused by inadequate charging or if the battery is left in a deeply discharged state.

M. Configurable output current

A fully configurable setting that limits the maximum charge current to a reduced level; beneficial when charging lower capacity batteries with a high current output charger.

N. Recovery function

The charger will attempt to recharge a severely discharged battery (even down to 0V) with low current and then resume normal charging once the battery voltage has risen sufficiently; many other chargers will not recognise a battery in this state.

O. Power supply mode

A specific mode to use the charger as a DC power supply; to power equipment at a constant voltage with or without a battery connected.

4. Operation

4.1. Charge algorithm

The **Blue Smart IP22 Charger** range are intelligent multi-stage battery chargers, specifically engineered to optimise each recharge cycle and charge maintenance over extended periods.

The multi-stage charge algorithm includes the individual charge stages described below:

1. Bulk

The battery is charged at maximum charge current until the voltage increases to the configured absorption voltage.

The bulk stage duration is dependent on the battery's level of discharge, the battery capacity and the charge current.

Once the bulk stage is complete, the battery will be approximately 80% charged (or >95% for Li-ion batteries) and may be returned into service if required.

2. Absorption

The battery is charged at the configured absorption voltage, with the charge current slowly decreasing as the battery approaches full charge.

The default absorption stage duration is adaptive and intelligently varied depending on the battery's level of discharge (determined from the duration of the bulk charge stage).

Adaptive absorption stage duration can vary between a minimum of 30 minutes, up to a maximum limit of 8 hours (or as configured) for a deeply discharged battery.

Alternatively, fixed absorption duration can be selected; fixed absorption duration is the automatic default when Li-ion mode is selected.

Absorption stage can also be ended early based on the tail current condition (if enabled), which is when the charge current drops below the tail current threshold.

3. Recondition

The battery voltage is attempted to be increased to the configured recondition voltage, while the charger output current is regulated to 8% of the nominal charge current (for example: 1.2A maximum for a 15A charger).

Recondition is an optional charge stage for lead acid batteries and not recommended for regular/cyclic use; use only if required, as unnecessary or overuse will reduce battery life due to excessive gassing.

The higher charge voltage during recondition stage can partially recover/reverse battery degradation due to sulfation, typically caused by inadequate charging or if the battery is left in a deeply discharged state for an extended period (if performed in time).

The recondition stage may also be applied to flooded batteries occasionally to equalise individual cell voltages and prevent acid stratification.

Recondition stage is terminated as soon as the battery voltage increases to the configured recondition voltage or after a maximum duration of 1 hour (or as configured).

Note that in certain conditions it is possible for the recondition state to end before the configured recondition voltage is achieved, such as when the charger is simultaneously powering loads, if the battery was not fully charged before recondition stage commenced, if the recondition duration is too short (set to less than one hour) or if the charger output current is insufficient in proportion to the capacity of the battery/battery bank.

4. Float

The battery voltage is maintained at the configured float voltage to prevent discharge.

Once float stage is commenced the battery is fully charged and ready for use.

The float stage duration is also adaptive and varied between 4 to 8 hours depending on the duration of the absorption charge stage, at which point the charger determines the battery to be in storage stage.

5. Storage

The battery voltage is maintained at the configured storage voltage, which is slightly reduced compared to the float voltage to minimise gassing and extend battery life whilst the battery is unused and on continuous charge.

6. Repeated absorption

To refresh the battery and prevent slow self-discharge while in storage stage over an extended period, a 1 hour absorption charge will automatically occur every 7 days (or as configured).

The indicator LEDs display the active charge state; refer to the image below:



Alternatively, a Bluetooth enabled device (mobile phone or tablet) with the **VictronConnect** app can be used to view the active charge state; refer to the 'Monitoring > VictronConnect' section for more information.

4.2. Charge modes

There are 3 integrated charge modes (Normal, High and Li-Ion), as well as an optional Recondition stage that can be included (except for Li-ion mode).

The integrated charge modes combined with adaptive charge logic are well suited for most common battery types; such as flooded lead-acid, AGM, Gel and LiFePO₄.

The required charge mode can be selected via the **MODE** button on the charger or a Bluetooth enabled device (mobile phone or tablet) with the **VictronConnect** app; refer to the 'Setup > Setup using the charger' or 'Setup > Setup using VictronConnect' section for more information.

If necessary, advanced configuration with user defined settings is also possible using a Bluetooth enabled device (mobile phone or tablet) with the **VictronConnect** app; refer to the 'Advanced configuration > Advanced settings' and 'Advanced configuration > Expert mode settings' sections for more information.

All settings are stored and will not be lost when the charger is disconnected from mains power or the battery.

4.2.1. Charge voltage

The charge voltage settings for each of the integrated charge modes are specified in the table below:

Mode	Absorption		Float		Storage		Recondition	
	12V	24V	12V	24V	12V	24V	12V	24V
Normal	14.4V	28.8V	13.8V	27.6V	13.2V	26.4V	Disabled	
Normal + Recondition	14.4V	28.8V	13.8V	27.6V	13.2V	26.4V	16.2V	32.4V
High	14.7V	29.4V	13.8V	27.6V	13.2V	26.4V	Disabled	
High + Recondition	14.7V	29.4V	13.8V	27.6V	13.2V	26.4V	16.5V	33.0V
Li-ion	14.2V	28.4V	Disabled		13.5V	27.0V	Disabled	



To ensure proper charging, battery longevity and safe operation it is important to select a charge mode appropriate for the battery type and capacity being charged; refer to the battery manufacturer's recommendations.

The **Blue Smart IP22 Charger** range feature temperature compensation, which will automatically optimise the nominal/configured charge voltage based on ambient temperature (except for Li-ion mode or if manually disabled); refer to the 'Operation > Temperature compensation' section for more information.

4.2.2. Recondition mode

Recondition is an optional charge stage for lead acid batteries and not recommended for regular/cyclic use; use only if required, as unnecessary or overuse will reduce battery life due to excessive gassing.

When recondition mode is enabled the recondition stage is included within the charge cycle (after the absorption stage is complete) and the battery voltage will be increased to an elevated level; refer to the 'Operation > Charge algorithm' section for more information.

When the recondition mode is enabled the RECONDITION LED will be illuminated and blink during recondition stage.

Recondition mode can be enabled and disabled via the MODE button on the charger or a Bluetooth enabled device (mobile phone or tablet) with the **VictronConnect** app; refer to the 'Setup > Setup using the charger' or 'Setup > Setup using VictronConnect' section for more information.

4.2.3. Low current mode

When low current mode is enabled the maximum charge current is limited to 50% of the maximum rated charge current and the cooling fan is disabled; refer to the 'Technical Specifications' section for more information .

Low current mode is recommended when charging lower capacity batteries with a high current charger; charging at an excessive charge current can cause premature battery degradation and overheating.

Typically the maximum charge current for lead acid based batteries should not exceed $\sim 0.3C$ (more than 30% of the battery capacity in Ah) and the maximum charge current for LiFePO4 batteries should not exceed $\sim 0.5C$ (more than 50% of the battery capacity in Ah).

When low current mode is enabled the NIGHT LED will blink.

Low current mode can be enabled and disabled via the MODE button on the charger or a Bluetooth enabled device (mobile phone or tablet) with the **VictronConnect** app; refer to the 'Setup > Setup using the charger' or 'Setup > Setup using VictronConnect' section for more information.



It is also possible to set the charge current limit to a user defined value between the maximum rated charge current and the minimum charge current limit (25% of maximum) using a Bluetooth enabled device (mobile phone or tablet) with the **VictronConnect** app; refer to the 'Advanced Configuration > Advanced settings' section for more information.

When the charge current limit is set to or below 50% of the maximum rated charge current the NIGHT LED will blink.

4.2.4. Night mode

When night mode is enabled the maximum charge current is limited to 50% of the maximum rated charge current and the cooling fan will be disabled for a period of 8 hours (typically overnight).

Once 8 hours have elapsed or if the charger is disconnected from mains power, night mode will be disabled and the charger will return to normal operation with maximum rated charge current available, and cooling fan operation enabled.

Night mode is particularly useful to provide a period of totally silent operation when charging overnight.

When night mode is enabled the NIGHT LED will be illuminated.

Night mode can be enabled and disabled via the MODE button on the charger or a Bluetooth enabled device (mobile phone or tablet) with the **VictronConnect** app; refer to the 'Setup > Setup using the charger' or 'Setup > Setup using VictronConnect' section for more information.

4.3. Temperature compensation

The **Blue Smart IP22 Charger** range feature temperature compensation, which will automatically optimise the nominal/ configured charge voltage based on ambient temperature (except for Li-ion mode or if manually disabled).

The optimal charge voltage of a lead-acid battery varies inversely with battery temperature; automatic temperature-based charge voltage compensation avoids the need for special charge voltage settings in hot or cold environments.

During power up the charger will measure its internal temperature and use that temperature as the reference for temperature compensation, however the initial temperature measurement is limited to 25°C as it's unknown if the charger is still warm from earlier operation.

Since the charger generates some heat during operation, the internal temperature measurement is only used dynamically if the internal temperature measurement is considered reliable; when the charge current has decreased to a low/negligible level and adequate time has elapsed for the charger's temperature to stabilise.

For more accurate temperature compensation, battery temperature data can be sourced from a compatible battery monitor (such as a BMV, SmartShunt, Smart Battery Sense or VE.Bus Smart Dongle) via VE.Smart Networking; refer to the 'Operation > VE.Smart Networking' section for more information.

The configured charge voltage is related to a nominal temperature of 25°C and linear temperature compensation occurs between the limits of 6°C and 50°C based on the default temperature compensation coefficient of -16.2mV/°C for 12V chargers (-32.4mV/°C for 24V chargers) or as configured.

Refer to the graph below for the default temperature vs charge voltage curve for 12V chargers:

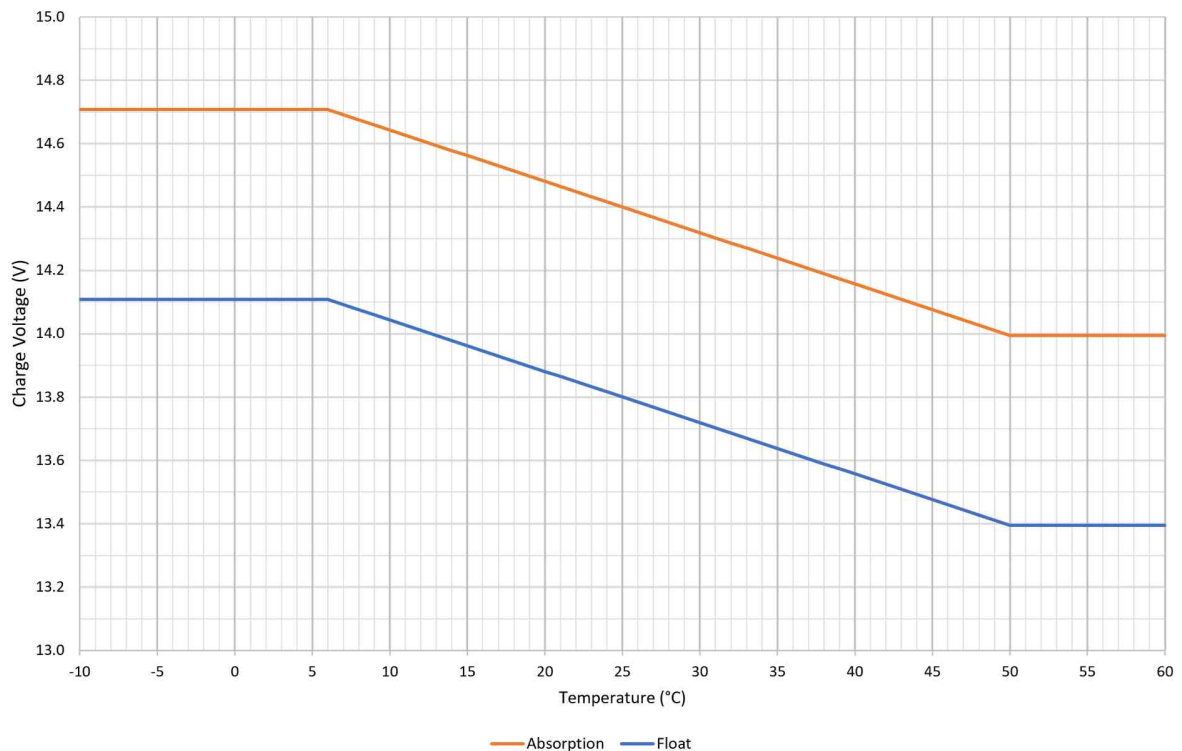

The temperature compensation coefficient is specified in mV/°C and applies to the entire battery/battery bank (not per battery cell).

If the battery manufacturer specifies a temperature compensation coefficient per cell, it will need to be multiplied by the total number of cells in series (there are typically 6 cells in series within a 12V lead-acid based battery).

4.4. VE.Smart networking

The **Blue Smart IP22 Charger** range feature **VE.Smart networking** capability, which enables Bluetooth communication between compatible Victron products to optimise charger operation and battery performance/life.

This powerful feature enables chargers to receive accurate battery voltage (**Volt-sense**), charge current (**Current-sense**) and battery temperature (**Temp-sense**) data from a compatible battery monitor (such as a BMV, SmartShunt, Smart Battery Sense or VE.Bus Smart Dongle) and/or multiple chargers to operate in unison with synchronised charging to further enhance the charge cycle.

A single compatible battery monitor (such as a BMV, SmartShunt, Smart Battery Sense or VE.Bus Smart Dongle) will provide voltage, temperature and/or current sense data to all (a single or multiple) chargers within the common **VE.Smart network**.

Multiple compatible chargers in a common **VE.Smart network** (with or without a battery monitor) will also synchronise their charge algorithm (known as synchronised charging).



1. Only one battery monitor (BMV, SmartShunt, Smart Battery Sense or VE.Bus Smart Dongle) can be included in a **VE.Smart network**.
2. All battery monitor connections (voltage sensing cables, temperature sensor and current shunt) and chargers in a common **VE.Smart network** must be connected to the same battery / battery bank.
3. The maximum number of devices permitted in a **VE.Smart network** is 10.
4. Communication via **VE.Smart networking** requires all devices to be located within Bluetooth range of each other. Systems with poor or intermittent Bluetooth signal between devices will experience connection issues. Signal strength between devices can be checked in the **VictronConnect VE.Smart networking** page.
5. Multiple chargers in a common **VE.Smart network** must have the same charge settings, since the master can change dynamically any charger could become the master.
6. Multiple chargers in a common **VE.Smart network** do not need to be the same type or model, they just need to be VE.Smart Networking compatible (this includes VE.Smart Networking compatible Blue Smart chargers, Smart IP43 chargers and MPPT solar chargers).
7. Some older devices may not be **VE.Smart networking** compatible or have limitations; refer to the **VE.Smart Networking** Product Compatibility table in the [VE.Smart Networking manual](#) to confirm.
8. Only **Blue Smart IP22 Chargers** with hardware revision 2 or later, introduced production week 24 of 2020, are **VE.Smart networking** compatible. Refer to the product label on the back of the charger to confirm the hardware revision ("hw rev 02" or later) and/or production date ("SN: HQ2024xxxxx" or later).

4.4.1. Voltage sense

Voltage Sense uses battery voltage data that is accurately measured directly at the battery terminals (or very close) and provides it to the charger, the charger then uses this voltage data to dynamically increase the output voltage and precisely compensate for voltage drop in the cabling and connections between the charger and battery.

This enables the battery to be charged with the exact voltage as configured in the charger, instead of a lower voltage due to voltage drop in the cabling and connections.

Voltage drop is proportional to the charge current and cabling/connection resistance ($V=I \times R$), so voltage drop will vary during a charge cycle and can be quite significant when charging at higher charge currents through cabling and connections with higher than optimal resistance; in this scenario voltage sense will be particularly beneficial.

Note that voltage sense does **not** allow inadequately rated cabling/connections to be used or compensate for excessively high voltage drop; for reliable and safe operation cabling and connections must all be suitably rated and appropriately sized for the application; refer to the 'Installation > Wiring' section for more information.

4.4.2. Temperature sense

Temperature Sense uses battery temperature data that is accurately measured directly at a battery terminal or on the battery body and provides it to the charger, the charger then uses this temperature data to dynamically compensate the charge voltage (decrease or increase) according to the specified temperature coefficient ($X \text{ mV}/^{\circ}\text{C}$).

The optimal charge voltage of a lead acid based battery varies inversely with battery temperature with the nominal charge voltage specified at 25°C; automatic temperature-based charge voltage compensation avoids the need for manual charge voltage setting adjustments in hot or cold environments.

For lithium batteries the optimal charge voltage remains constant under all normal operating temperatures, however lithium batteries can be permanently damaged if charged in cold conditions; in this case the temperature sense data can be used to automatically disable charging in cold conditions (typically <5°C).

4.4.3. Current sense

Current Sense uses battery current data that is measured by the battery monitor shunt (requires a BMV or SmartShunt) and provides it to the charger, the charger then references this current data (as opposed to the charger output current) for the tail current setting.

The tail current setting references the diminishing level of charge current (typical at the end of a full charge cycle) in relation to the trigger threshold to determine when the battery is fully charged and consequently when the absorption stage can be ended (prior to the absorption stage time limit being reached). The use of tail current to end absorption stage is a highly effective and common method used to properly charge lead acid based batteries.

In order to end the absorption phase at the correct point, it is important that the true current flow into the battery is referenced in relation to the tail current threshold, rather than the charger output current which may be significantly higher; if any loads are powered while charging a portion of the charger output current will be flowing directly to the loads, making the tail current condition more difficult or impossible to meet without current sense.

4.4.4. Synchronised charging

Synchronised charging capability enables multiple compatible chargers to be combined together in a common **VE.Smart network**, allowing the chargers to operate in unison as if they were one large charger.

The chargers will synchronise the charge algorithm between themselves with no further hardware or physical connections required, and simultaneously change charge states.

Synchronised charging works by systematically prioritising all chargers and assigning one as the master, this charger then controls the charge stage of all other slave chargers. In case the initial master is disconnected from the **VE.Smart Network** for any reason (out of Bluetooth range for example), another charger will be systematically reassigned as the master and take over control; this can also be reversed if communication with the initial master (that has a higher priority) is re-established. The master charger can not be manually selected.

Synchronised charging does not regulate or equalise the current output of multiple chargers, each charger still has total control over it's own current output. Accordingly, current output variation between multiple chargers is normal (primarily dependent on cable resistance and charging conditions) and a total system current output limit cannot be configured.

Synchronised charging can be setup with different charger types, providing they are **VE.Smart Networking** compatible (this includes compatible Blue Smart IP22 chargers, Smart IP43 chargers and SmartSolar MPPT solar chargers). Charging from solar chargers is not prioritised over mains supply chargers, so in some installations (primarily dependent on cable resistance and charging conditions) it is possible for solar power to be underutilised.

Synchronised charging can also be used in conjunction with a battery monitor (BMV, SmartShunt, Smart Battery Sense or VE.Bus Smart Dongle) to provide voltage, temperature and/or current sense data to the chargers in a common **VE.Smart network**; refer to the 'Operation > VE.Smart Networking > Voltage sense / Temperature sense / Current sense' sections for more information.

In the absence of a battery monitor providing current-sense data (requires a BMV or SmartShunt), the charge current from each individual charger is combined by the master and referenced against the tail current setting.

4.5. Commencing a new charge cycle

A new charge cycle will commence when:

1. The configured Re-bulk condition is satisfied (typically due to a large load):
 - A. Re-bulk method set to Current and Re-bulk current is disabled (default configuration): The current output must be maintained at the maximum current output for four seconds.
 - B. Re-bulk method is set to Current and Re-bulk current is configured with a user defined value: The current output must exceed the configured Re-bulk current for four seconds while the charger is in float or storage stage.
 - C. Re-bulk method is set to Voltage and Re-bulk voltage offset is configured with a user defined value: The battery voltage must drop below the configured Re-bulk voltage for one minute.
 - D. The charger is in a VE.Smart network with synchronised charging: The battery voltage must drop below the configured Re-bulk voltage for one minute (regardless of the Re-bulk method selected).
2. The **MODE** button is pressed or used to select a new charge mode.
3. **VictronConnect** is used to select a new charge mode or change the function from Power Supply to Charger mode.
4. The power supply to the AC power supply has been disconnected and reconnected.

4.6. Estimating charge time

The time required to recharge a battery to 100% SOC (state of charge) is dependant on the battery capacity, the depth of discharge, the charge current and the battery type/chemistry, which has a significant effect on the charge characteristics.

4.6.1. Lead-acid based chemistry

A lead-acid battery is normally at approximately 80% state of charge (SOC) when the bulk charge stage is completed.

The bulk stage duration T_{bulk} can be calculated as $T_{\text{bulk}} = Ah / I$, where I is the charge current (excluding any loads) and Ah is the depleted battery capacity below 80% SOC.

The absorption stage duration T_{abs} will vary depending on the depth of discharge; up to 8 hours of absorption may be required for a deeply discharged battery to reach 100% SOC.

For example, the time required to recharge a fully discharged Lead-acid based 100Ah battery with a 10A charger would be approximately:

- **Bulk stage** duration, $T_{\text{bulk}} = 100Ah \times 80\% / 10A = 8$ hours
- **Absorption stage** duration, $T_{\text{abs}} = 8$ hours
- **Total** charge duration, $T_{\text{total}} = T_{\text{bulk}} + T_{\text{abs}} = 8 + 8 = 16$ hours

4.6.2. Li-ion based chemistry

A Li-ion based battery is normally well above 95% state of charge (SOC) when the bulk charge stage is completed.

The bulk stage duration T_{bulk} can be calculated as $T_{\text{bulk}} = Ah / I$, where I is the charge current (excluding any loads) and Ah is the depleted battery capacity below 95% SOC.

The absorption stage duration T_{abs} required to reach 100% SOC is typically less than 30 minutes.

For example, the charge time of a fully discharged 100Ah battery when charged with a 10A charger to approximately 95% SOC is $T_{\text{bulk}} = 100 \times 95\% / 10 = 9.5$ hours.

For example, the time required to recharge a fully discharged Li-ion based 100Ah battery with a 10A charger would be approximately:

- **Bulk stage** duration, $T_{\text{bulk}} = 100Ah \times 95\% / 10A = 9.5$ hours
- **Absorption stage** duration, $T_{\text{abs}} = 0.5$ hours
- **Total** charge duration, $T_{\text{total}} = T_{\text{bulk}} + T_{\text{abs}} = 9.5 + 0.5 = 10$ hours

4.7. Multiple isolated outputs

The **Blue Smart IP22 Charger** 3 output models include an integrated FET battery isolator and multiple isolated outputs.

Multiple isolated outputs make it possible for a single charger to charge multiple individual batteries that are at a different voltage/SOC level without current flow between the batteries, and with the charge current intrinsically distributed between all batteries depending on their voltage/SOC level and capacity.

The 3 output charger models can supply the full rated output current from all 3 outputs; however the combined current of all outputs is limited to the full rated output current.



The multiple isolated outputs are not regulated individually, one charge algorithm (charge cycle and charge voltage) is applied to all outputs; accordingly all batteries will need to be compatible with the common charge algorithm (typically the same chemistry type).

5. Installation

5.1. Mounting

The **Blue Smart IP22 Charger** range is designed to be permanently mounted using the mounting tabs on the base of the charger.

Before mounting, the following aspects should be considered to identify/provide a suitable and safe location:

- Install the charger in a location with good natural airflow/ventilation; in case airflow is a restricted, consider adding a cooling fan.
- Ensure there is sufficient unobstructed space around the charger; a minimum clearance of 100mm above and below is recommended.
- Install the charger on a non-flammable substrate and ensure there are no heat-sensitive items in the immediate vicinity; it is normal for the charger to become hot during operation.
- Install the charger in a location where it is protected from environmental conditions such as water, high moisture and dust, and also located well away from any flammable liquids or gasses.
- Do not install or place/operate the charger on top of the battery, directly above the battery, or in a sealed compartment with the battery; batteries can emit explosive gasses.
- Do not cover or place any other items on top of the charger.

Mount the **Blue Smart IP22 Charger** vertically with the terminals facing down; secure using suitable screws through the mounting holes/slots.

Select and use screws with a pan/flange head (do not use screws with a countersunk/tapered head), and a screw thread outer diameter well matched to the mounting hole/slot internal diameter (~4mm max OD to provide a clearance fit).

To aid installation, it is recommended to support the unit using the 2 lower screws (leave the screw heads ~3mm from the surface) and then install the 2 upper screws, before fully securing all 4 screws.

Take care to not over-tighten the mounting screws (as the mounting flanges are plastic), and to not damage the AC power cable while securing the lower left mounting screw (as the AC power cable is located directly above it).

Refer to the drawing below for mounting dimensions:

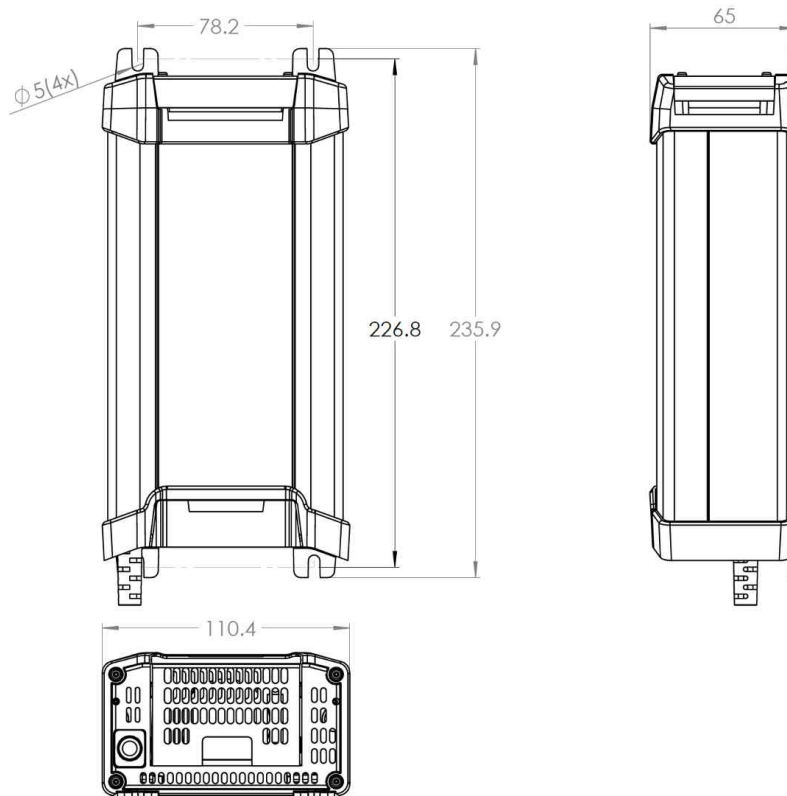

5.2. Wiring

1. Connect suitable DC power cabling to the **Blue Smart IP22 Chargers** BATTERY terminals.

A. Remove the terminal cover by gently applying outward pressure on the cover upper face.

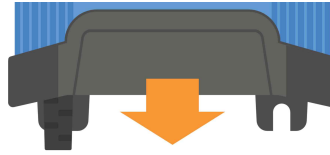

B. Prepare flexible multi stranded copper DC power cable with sufficient cross sectional area; refer to the 'Installation > Wiring > DC power cable' section for more information.

C. Connect the positive DC cable (red insulation) to the positive (+) terminal and the negative DC cable (black insulation) to the negative (-) terminal connection; ensure that the cable connection polarity is correct.

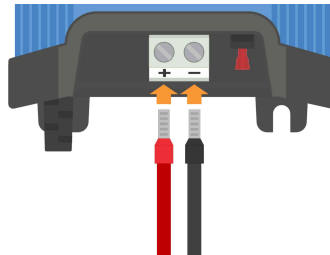

D. Torque the terminal screws to 2.4Nm using a suitable torque wrench and screw driver bit, then reinstall the terminal cover.

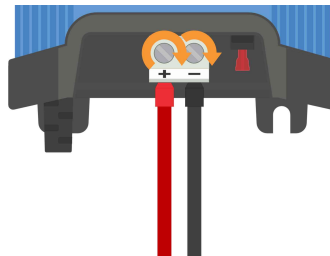

2. Install a suitably rated inline fuse or circuit breaker within the DC power cabling between the **Blue Smart IP22 Charger** and battery/batteries, located as close as practical to the battery/batteries; refer to the 'Installation > Wiring > Overcurrent protection' section for more information.

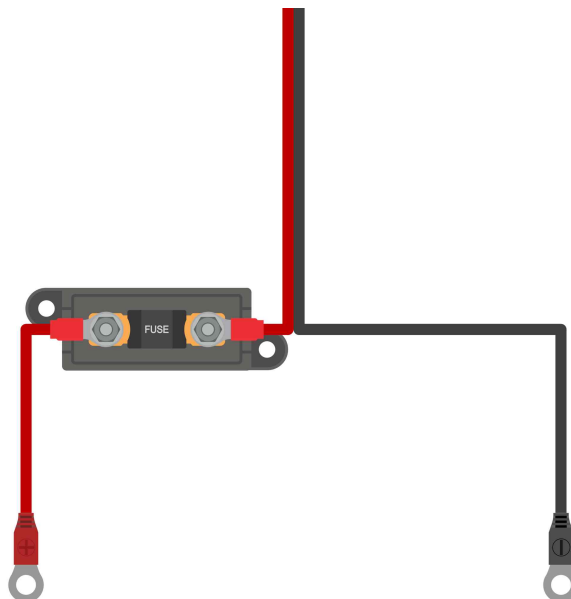

3. Connect the DC power cabling to the battery/batteries or DC system distribution bus - follow the instructions relevant to the installation type.
 - A. **For hardwired installations, or when charging a battery outside of a vehicle/installation:**
 - i. Ensure that the DC system is shut down (all DC loads and charge sources off/isolated) prior to disconnection of any existing battery / DC system distribution bus cabling and connection of the charger to the battery terminals / DC system distribution bus.
 - ii. Connect the positive DC cable (red insulation) to the positive (+) terminal and the negative DC cable (black insulation) to the negative (-) terminal connection; ensure that the cable connection polarity is correct.
 - iii. Torque all wiring termination hardware to manufacturers torque specifications using a suitable torque wrench and socket / screw driver bit.
 - B. **For temporary installations when charging a battery installed within a vehicle, and the negative (-) battery terminal is grounded to the vehicle chassis (conventional):**
 - i. Connect the positive DC cable / battery clamp (red insulation) directly to the battery positive (+) terminal first.
 - ii. Then connect the negative DC cable / battery clamp (black insulation) to a suitable grounding point on the vehicle chassis (not directly to the negative battery terminal).
 - iii. When disconnecting the charger, disconnect the DC cables / battery clamps in reverse of the connection order.
 - C. **For temporary installations when charging a battery installed within a vehicle, and the positive (+) battery terminal is grounded to the vehicle chassis (unconventional):**
 - i. Connect the negative DC cable / battery clamp (black insulation) directly to the battery negative (-) terminal first.
 - ii. Then connect the positive DC cable / battery clamp (red insulation) to a suitable grounding point on the vehicle chassis (not directly to the positive battery terminal).
 - iii. When disconnecting the charger, disconnect the DC cables / battery clamps in reverse of the connection order.
4. Connect the **Blue Smart IP22 Charger** AC power cable to a mains power outlet; after a short delay the LEDs indicating the current charge mode and charge state will illuminate.

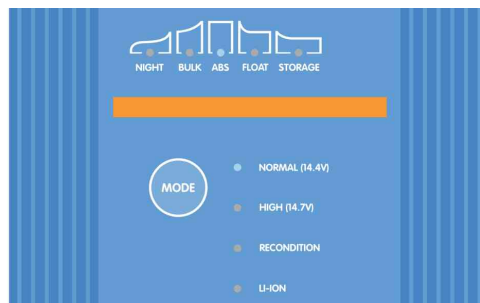

Example wiring schematics depicting most typical installation configurations are also provided for reference; refer to the 'Installation > Schematics' section for more information.

5.2.1. DC power cable

The **Blue Smart IP22 Charger** range features rising clamp screw terminals for connection to DC power cabling, which is not included and needs to be supplied by the installer.

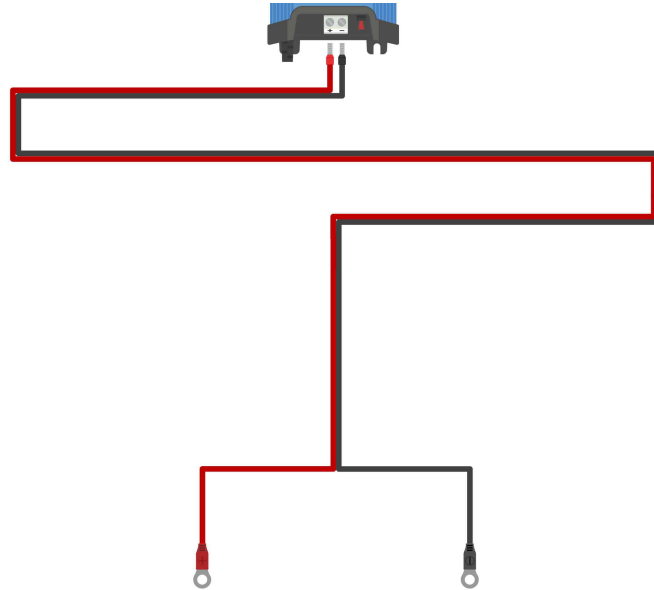

To ensure optimal and reliable operation, it is important to select high quality flexible DC power cabling that is suitable for the specific charger model and the overall installation; DC power cable selection should consider the following aspects:

1. Cable size/gauge

Conductor cross sectional area is proportional to the resistance of a cable per unit length, which effects the amount of heat generated per unit length and the voltage drop over the total cable length.

A. Current carrying capacity

Current carrying capacity is the maximum current a cable size/gauge can carry in a particular installation environment without exceeding the temperature limit of the cable insulation; accordingly current carrying capacity is dependent on cable size/gauge, the installation environment and the insulation temperature limit.

To prevent overheating of the DC power cable and/or interfacing equipment, the maximum current rating for the selected cable size/gauge (including any de-rating applicable to the installation) must exceed the maximum normal operating current and also the rating of the fuse or circuit breaker installed (in case of an overcurrent fault).

B. Voltage drop %

Voltage drop percentage is the maximum voltage lost over the cable length, expressed as a percentage in relation to the nominal operating voltage; accordingly voltage drop % is dependent on cable size/gauge, total cable length and the nominal operating voltage.

To prevent excessive power loss and operational issues due to high voltage drop, design the system layout to minimise DC power cable length and select a cable size/gauge that provides a voltage drop of 3% or less (at maximum normal operating current).

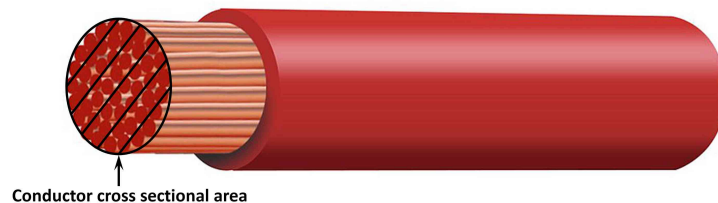

2. Conductor

The conductor material and specifications effect the resistance of a cable per unit length (effecting current carrying capacity), the resistance and heat generated at terminations, and overall cable flexibility.

A. Conductor material and configuration

Use high quality flexible DC power cabling that consists of fine multi-stranded oxygen free copper conductors.

B. Strand diameter

Strand diameter effects the contact area and accordingly the resistance at terminations; a high resistance termination will generate substantial heat when operating under load and can result in severe overheating.

To maximise contact area at terminations and prevent overheating at/near terminations, the diameter of each individual copper strand must not exceed 0.4mm (0.016 inch) or a surface area of 0.125mm² (AWG26).

C. Flexibility class

To facilitate installation with practical bend radii and prevent failure of the cable and/or interfacing equipment due to excessive force/stress at terminations and/or cyclic fatigue, use high quality flexible DC power cabling with a flexibility class of 5 - Flexible copper conductors, or 6 - Extra flexible copper conductors.

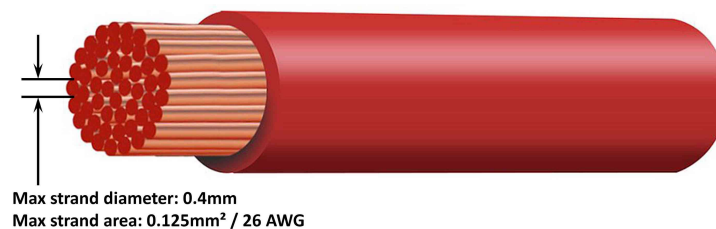

3. Insulation

The insulation material and specifications effect the maximum temperature capability/rating (effecting current carrying capacity) and the maximum voltage isolation capability/rating of a cable.

A. Temperature rating

The insulation temperature rating effects the current carrying capacity of a cable and must not be exceeded when considering the combination of a) maximum ambient temperature, b) the installation environment (which effects the dissipation of heat), and c) temperature rise due the heat generated by the cable when operating at the fuse or circuit breaker current rating.

To prevent overheating of the cable insulation, use high quality flexible DC power cabling with an insulation temperature rating of at least 90°/194°F (preferably 105°C/221°F), or as required for the installation.

B. Voltage rating

To ensure robust electrical isolation and overall safety, use high quality flexible DC power cabling with an insulation voltage rating that exceeds the maximum operating voltage of the system; high quality flexible DC power cabling typically has an insulation voltage rating of 0.6/1kV.

Refer to the table below for the minimum DC power cable size/gauge (cross sectional area) recommended for each **Blue Smart IP22 Charger** model, and the installation specific DC power cable length:

Charger model	Max current	Minimum cable size/gauge			
		<1.5m	1.5 to 3.0m	3.0 to 4.5m	4.5 to 6.0m
12/15	15A	2.5mm ² 14 AWG	6mm ² 10 AWG	10mm ² 8 AWG	10mm ² 8 AWG
12/20	20A	4mm ² 12 AWG	10mm ² 8 AWG	10mm ² 8 AWG	16mm ² 6 AWG
12/30	30A	10mm ² 8 AWG	10mm ² 8 AWG	16mm ² 6 AWG	Not recommended
24/8	8A	1.5mm ² 16 AWG	1.5mm ² 16 AWG	2.5mm ² 14 AWG	4mm ² 12 AWG
24/12	12A	2.5mm ² 14 AWG	2.5mm ² 14 AWG	4mm ² 12 AWG	4mm ² 12 AWG
24/16	16A	4mm ² 12 AWG	4mm ² 12 AWG	4mm ² 12 AWG	6mm ² 10 AWG



The DC power cable length ranges represent one way length between charger and battery, the total circuit length (positive and negative cable length) has been assumed to be double one way length for the voltage drop calculations.

Certain combinations are "Not recommended" as voltage drop would be excessive even with the largest compatible DC power cable size; in addition to high power loss, excessive voltage drop can cause charging issues.

The DC power cable size/gauge recommendations above are based on cabling with an insulation rating of at least 90°C (194°F) routed within an unenclosed area at 30°C (86°F) ambient temperature and not bundled with other cabling, and a 3% maximum voltage drop limit; these recommendations are generic and do not cover the intricacies of all installations and/or cable types, please consult a certified installer for guidance with specific and/or complex installations.

5.2.2. Overcurrent protection

To ensure reliable and safe operation, it is recommended to install a suitably rated inline fuse or circuit breaker within the DC power cabling between the **Blue Smart IP22 Charger** and battery/batteries, located as close as practical to the battery/batteries; this is particularly important for hardwired installations.

The primary purpose of an inline fuse or circuit breaker located close to the battery/batteries (energy source) is to protect the cabling and system in the event of an overcurrent fault, such as a short circuit in the DC power cabling; a fuse or circuit breaker located in the charger unit or nearby within the DC power cabling will not provide protection from a short circuit in the unprotected length of cabling.

In the event of a short circuit in the DC power cabling between the battery/batteries and charger, the battery/batteries have the capability to provide extremely high current through the DC power cabling, which can result in severe overheating of the cabling and potentially a fire unless the battery/batteries (energy source) is promptly disconnected by a suitable fuse or circuit breaker.

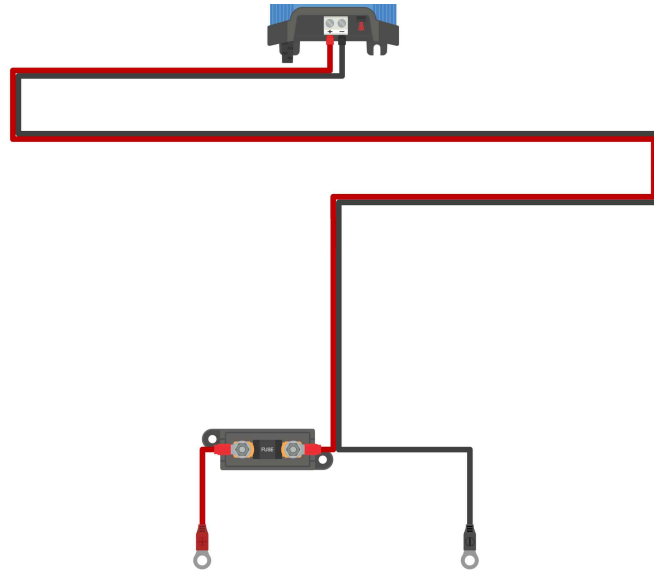

Refer to the table below for the recommended fuse / circuit breaker rating, depending on the charger model:

Charger model	Max current	Fuse / circuit breaker rating	
		Minimum	Maximum
12/15	15A	20A	30A
12/20	20A	30A	40A
12/30	30A	40A	70A
24/8	8A	15A	20A
24/12	12A	20A	30A
24/16	16A	25A	40A



The fuse / circuit breaker rating recommendations above are based on a 75% maximum normal operating current limit for the minimum fuse / circuit breaker rating and the maximum current capability of the related DC power cabling size/gauge for the maximum fuse / circuit breaker rating; these recommendations are generic and do not cover the intricacies of all installations and/or fuse / circuit breaker types, please consult a certified installer for guidance with specific and/or complex installations.

5.3. Schematics

5.3.1. Basic install

Single (1) output models - Basic hardwired install

Refer to the wiring schematic below to connect a single (1) output **Blue Smart IP22 Charger** to a single battery / battery bank:

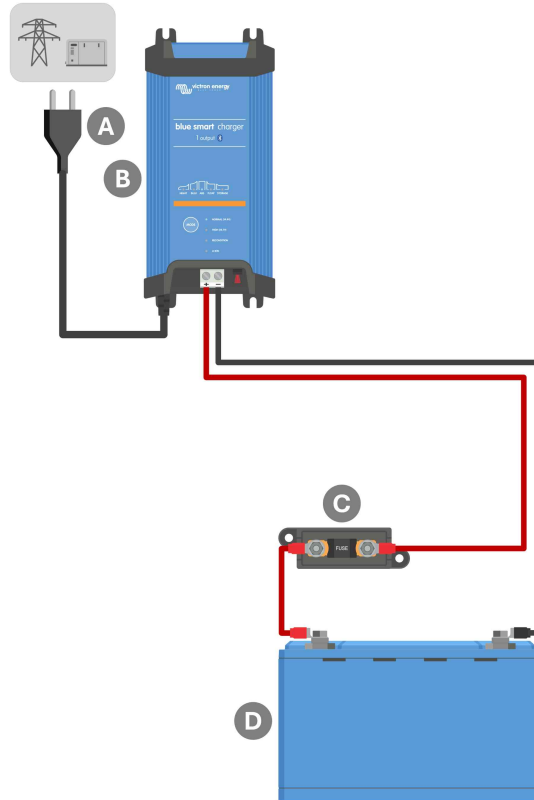

Key	Description
A	AC power supply (mains power grid, generator or inverter)
B	Blue Smart IP22 Charger (1 output model)
C	Fuse / circuit breaker (locate as close as practical to battery)
D	Battery / battery bank

Multiple (3) output models - Basic hardwired install

Refer to the wiring schematic below to connect a multiple (3) output **Blue Smart IP22 Charger** to multiple independent batteries / battery banks:

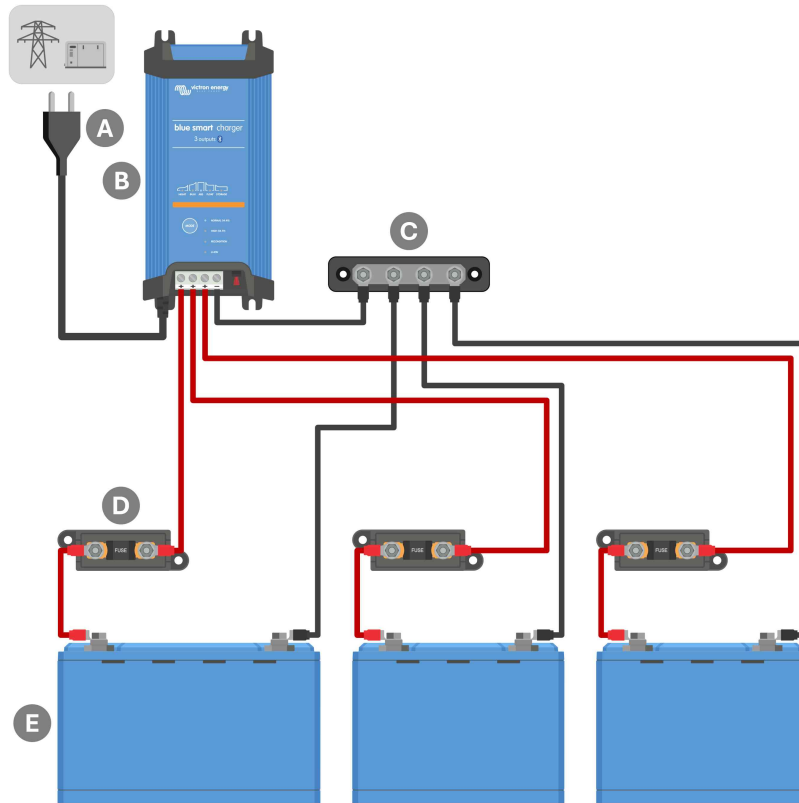

Key	Description
A	AC power supply (mains power grid, generator or inverter)
B	Blue Smart IP22 Charger (3 output model)
C	DC negative busbar
D	Fuses / circuit breakers x3 (locate as close as practical to batteries)
E	Batteries / battery banks x3 (any combination of 1, 2 or 3 batteries)

5.3.2. System with Smart Battery Sense

Single (1) output models - System with Smart Battery Sense

Refer to the wiring schematic below to connect a **Blue Smart IP22 Charger** (1 output model) to a single battery / battery bank, with a Smart Battery Sense in the system:

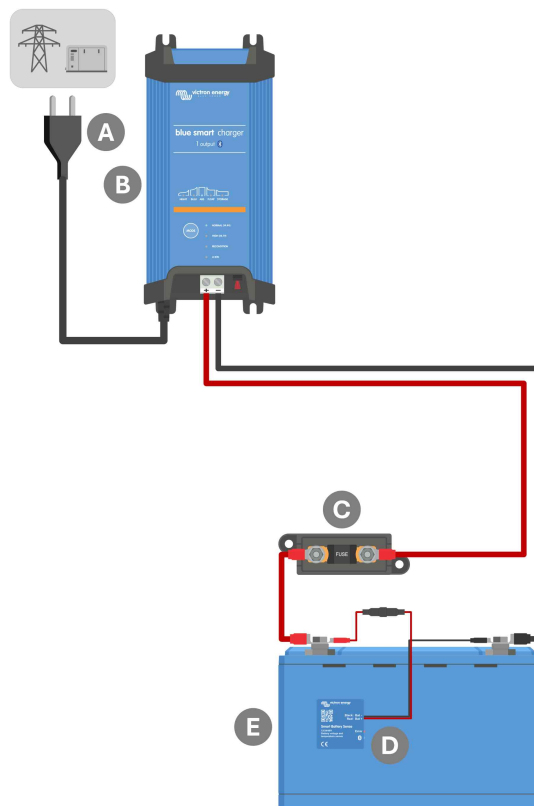

Key	Description
A	AC power supply (mains power grid, generator or inverter)
B	Blue Smart IP22 Charger (1 output model)
C	Fuse / circuit breaker (locate as close as practical to battery)
D	Smart Battery Sense
E	Battery / battery bank

i A **VE.Smart Network** must be setup between the **Blue Smart IP22 Charger** and Smart Battery Sense to enable Bluetooth connectivity and communication between devices; refer to the 'Advanced Configuration > VE.Smart Networking' section for more information.

Multiple (3) output models - System with Smart Battery Sense

Refer to the wiring schematic below to connect a **Blue Smart IP22 Charger** (3 output model) to multiple independent batteries / battery banks, with a Smart Battery Sense in the system:

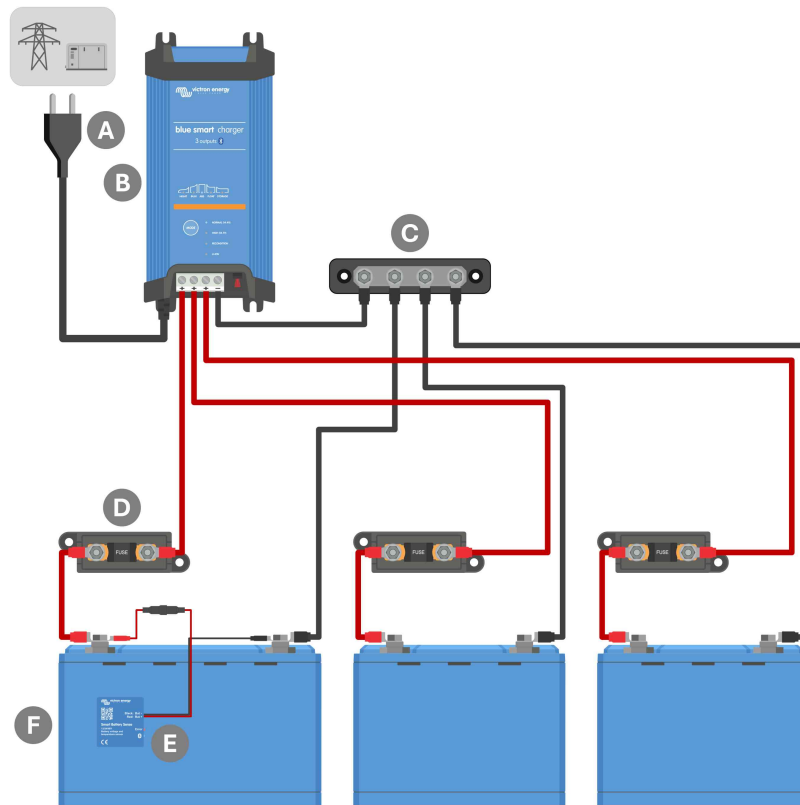

Key	Description
A	AC power supply (mains power grid, generator or inverter)
B	Blue Smart IP22 Charger (3 output model)
C	DC negative busbar
D	Fuses / circuit breakers x3 (locate as close as practical to batteries)
E	Smart Battery Sense
F	Batteries / battery banks x3 (any combination of 1, 2 or 3 batteries)

i A **VE.Smart Network** must be setup between the **Blue Smart IP22 Charger** and Smart Battery Sense to enable Bluetooth connectivity and communication between devices; refer to the 'Advanced Configuration > VE.Smart Networking' section for more information.

5.3.3. System with SmartShunt

Single (1) output models - System with SmartShunt

Refer to the wiring schematic below to connect a **Blue Smart IP22 Charger** (1 output model) to a single battery / battery bank, with a SmartShunt or BMV battery monitor in the system:

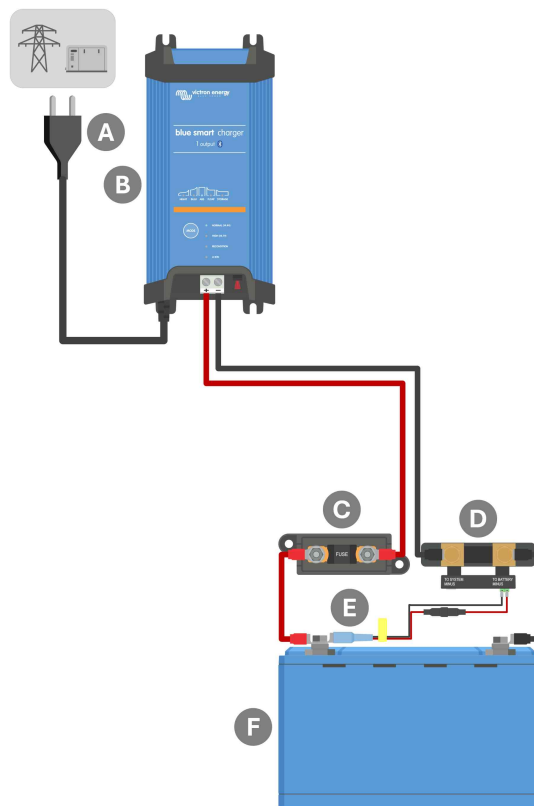

Key	Description
A	AC power supply (mains power grid, generator or inverter)
B	Blue Smart IP22 Charger (1 output model)
C	Fuse / circuit breaker (locate as close as practical to battery)
D	SmartShunt or BMV battery monitor shunt (locate as close as practical to battery)
E	Temperature and voltage sensor (Optional accessory, PN: ASS000100000)
F	Battery / battery bank



A **VE.Smart Network** must be setup between the **Blue Smart IP22 Charger** and SmartShunt or BMV battery monitor to enable Bluetooth connectivity and communication between devices; refer to the 'Advanced Configuration > VE.Smart Networking' section for more information.

Multiple (3) output models - System with SmartShunt

Refer to the wiring schematic below to connect a **Blue Smart IP22 Charger** (3 output model) to multiple independent batteries / battery banks, with a SmartShunt or BMV battery monitor in the system:

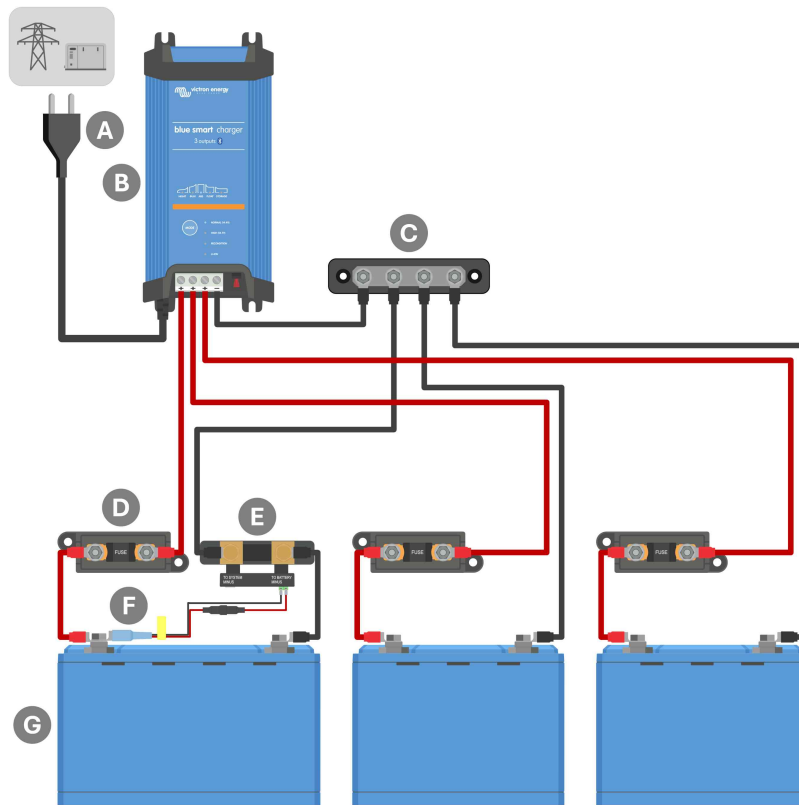

Key	Description
A	AC power supply (mains power grid, generator or inverter)
B	Blue Smart IP22 Charger (3 output model)
C	DC negative busbar
D	Fuses / circuit breakers x3 (locate as close as practical to batteries)
E	SmartShunt or BMV battery monitor shunt (locate as close as practical to battery)
F	Temperature and voltage sensor (Optional accessory, PN: ASS000100000)
G	Batteries / battery banks x3 (any combination of 1, 2 or 3 batteries)

i A **VE.Smart Network** must be setup between the **Blue Smart IP22 Charger** and SmartShunt or BMV battery monitor to enable Bluetooth connectivity and communication between devices; refer to the 'Advanced Configuration > VE.Smart Networking' section for more information.

5.3.4. System with multiple chargers

Multiple chargers in parallel (with optional SmartShunt)

Refer to the wiring schematic below to connect multiple **Blue Smart IP22 Chargers** in parallel to a single battery / battery bank, with an optional SmartShunt or BMV battery monitor in the system:

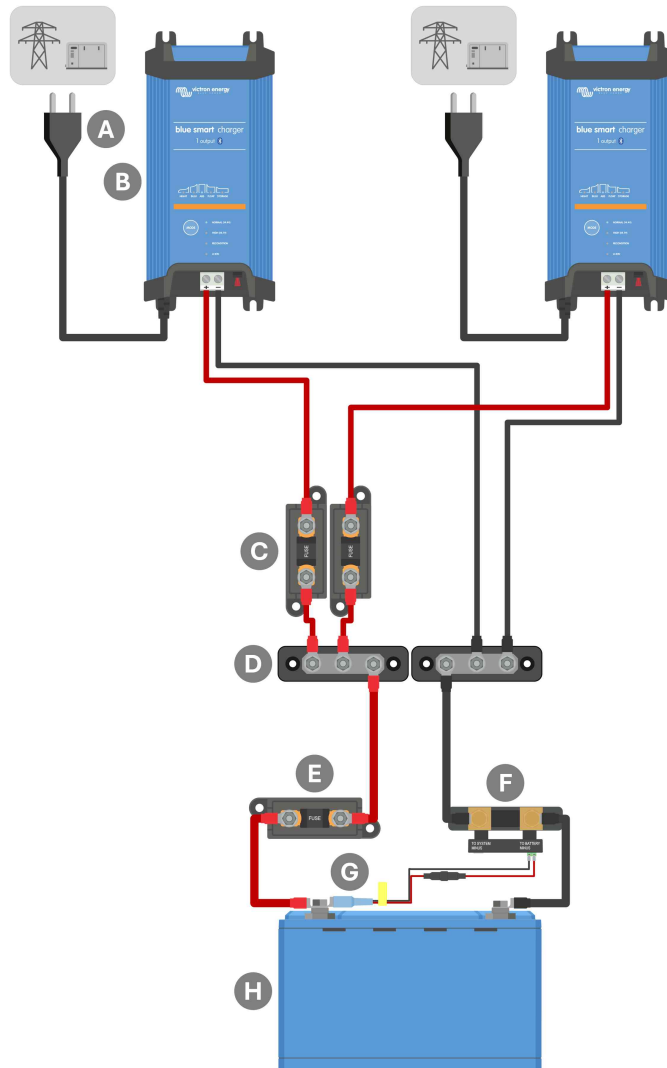

Key	Description
A	AC power supply x2 (mains power grid, generator or inverter)
B	Blue Smart IP22 Chargers x2
C	Fuses / circuit breakers x2 (locate as close as practical to DC positive busbar)
D	DC positive and negative busbar
E	Fuse / circuit breaker (locate as close as practical to battery)
F	SmartShunt or BMV battery monitor shunt (SmartShunt/BMV is optional, locate as close as practical to battery)
G	Temperature and voltage sensor (Optional accessory, PN: ASS000100000)
H	Battery / battery bank

i A **VE.Smart Network** must be setup between all **Blue Smart IP22 Chargers** connected in parallel (and the optional SmartShunt or BMV battery monitor, if used) to enable Bluetooth connectivity and communication between devices; refer to the 'Advanced Configuration > VE.Smart Networking' section for more information.

6. Setup

6.1. Setup using the charger

The charge mode and charge current limit most appropriate for the battery type and capacity can be selected using the **MODE** button on the **Blue Smart IP22 Charger**.

To setup using the charger:

1. Connect the **Blue Smart IP22 Charger** AC power cable to a mains power outlet; after a short delay the LEDs indicating the current charge mode and charge state will illuminate.

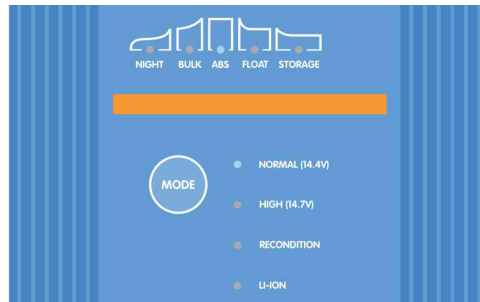

2. Press (and release) the **MODE** button on the **Blue Smart IP22 Charger** to cycle through and select the most appropriate integrated charge mode (Normal, Normal + Recondition, High, High + Recondition or Li-ion).

Ensure that recondition stage is only enabled when required, as unnecessary or overuse will reduce battery life.



3. The LED beside the currently selected charge mode (NORMAL / HIGH / LI-ION) will be illuminated, as well as the RECONDITION LED if enabled.



4. If the maximum rated charge current is excessive, enable low current mode (charge current limited to 50% of the maximum rated charge current and disabled fan). To enable (or disable) low current mode depress and hold down the **MODE** button on the **Blue Smart IP22 Charger** for 6 seconds; when enabled the NIGHT LED will blink.

Alternatively night mode can be enabled, which temporarily activates low current mode for a period of 8 hours (typically overnight to eliminate fan noise). To enable (or disable) night mode depress and hold down the **MODE** button on the **Blue Smart IP22 Charger** for 3 seconds; when enabled the NIGHT LED will be illuminated.

All settings are stored and will not be lost when the charger is disconnected from mains power or the battery.



To ensure proper charging, battery longevity and safe operation it is important to select a charge mode appropriate for the battery type and capacity being charged; refer to the 'Operation > Charge modes' section and the battery manufacturer's recommendations for more information.

6.2. Setup using VictronConnect

The charge mode and charge current limit most appropriate for the battery type and capacity can also be selected using a Bluetooth enabled device (mobile phone or tablet) with the **VictronConnect** app.

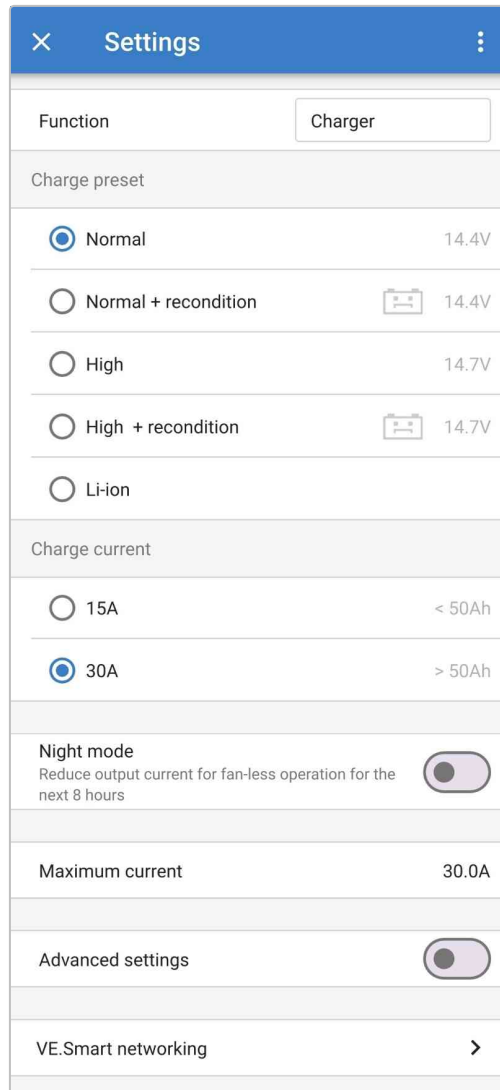

For further information about the **VictronConnect** app refer to the [VictronConnect manual](#).

To setup using Bluetooth:

1. Download and install the **VictronConnect** app onto the Bluetooth enabled device (mobile phone or tablet).

The **VictronConnect** app can be downloaded from the following locations:

- A. Android - Google Play Store
 - B. iOS/Mac - Apple App Store
 - C. Windows and other - [Victron Energy website > Downloads > Software](#)
2. Enable Bluetooth on the Bluetooth enabled device (mobile phone or tablet) if not already enabled, but do not attempt to pair with the **Blue Smart IP22 Charger**.

3. Connect the **Blue Smart IP22 Charger** AC power cable to a mains power outlet; after a short delay the LEDs indicating the current charge mode and charge state will illuminate.

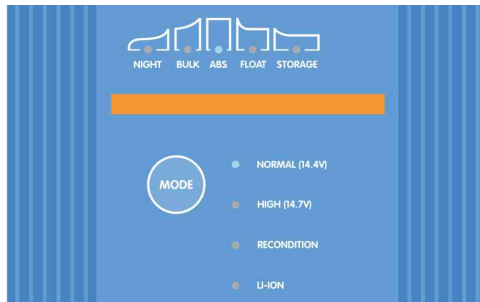

4. Open the **VictronConnect** app and locate the **Blue Smart IP22 Charger** in the Device list Local page, under Other devices. In case the **Blue Smart IP22 Charger** does not automatically appear, ensure that the mobile phone or tablet has Bluetooth enabled and is within close range, then perform a manual scan for devices by selecting the **Scan** button (round orange button with circular arrow) in the bottom right corner.

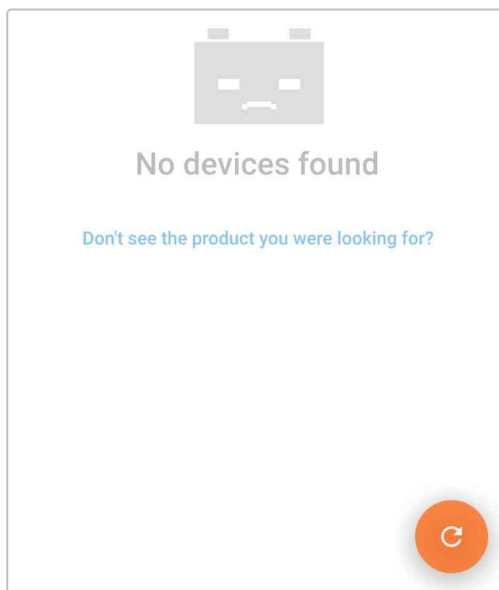

5. Select the **Blue Smart IP22 Charger** from the Device list Local page, under Other devices.

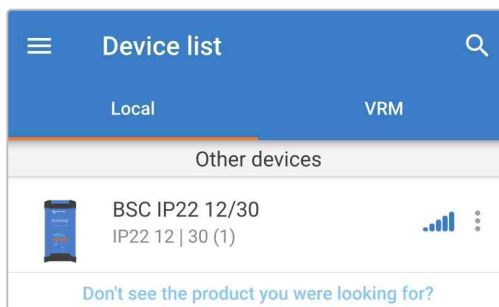

- 6. **VictronConnect** will attempt to establish a Bluetooth connection with the **Blue Smart IP22 Charger** and display the connection progress in the Connecting pop-up dialog box.

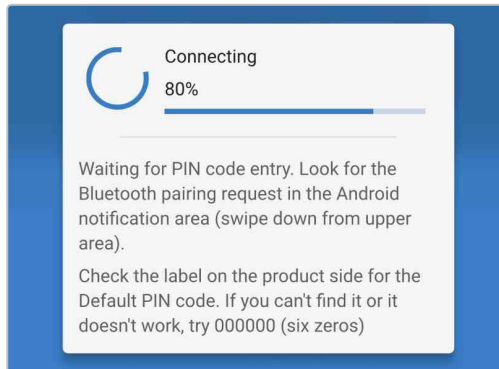

- 7. When attempting to establish a Bluetooth connection with a new/unpaired device, the Bluetooth pairing request pop-up dialog box will appear after a short delay; enter the default PIN code stated on a label located on the back of the charger (or try 000000 if there is no default PIN code label), then select **Pair**.

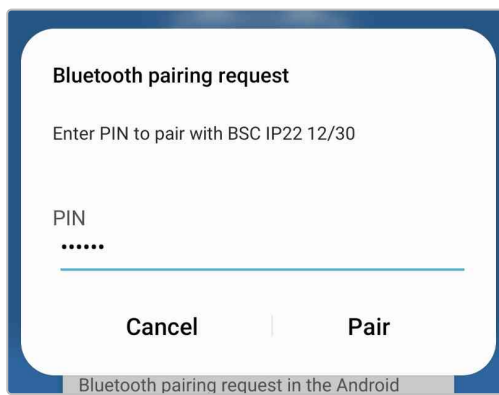

- 8. Select the **Settings** icon (gear in the top right corner) to access the Settings page.



- 9. Select the most appropriate integrated charge mode (Normal, Normal + Recondition, High, High + Recondition or Li-ion) from the Charge preset menu.

Ensure that recondition stage is only enabled when required, as unnecessary or overuse will reduce battery life.

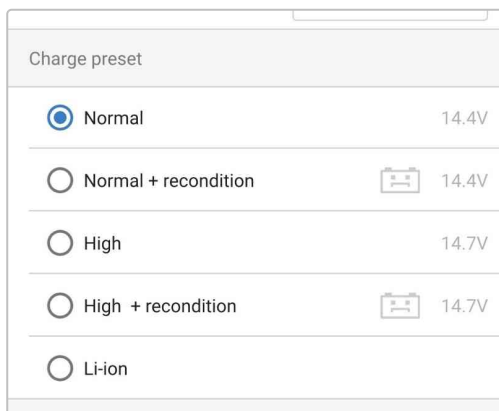

10. If the maximum rated charge current is excessive, enable low current mode (charge current limited to 50% of the maximum rated charge current). To enable (or disable) low current mode select the required option from the Charge current menu; when enabled the NIGHT LED will blink.

Alternatively night mode can be enabled, which temporarily activates low current mode for a period of 8 hours (typically overnight to eliminate fan noise). To enable (or disable) night mode toggle the **Night mode** switch on (or off to disable); when enabled the NIGHT LED will illuminate.

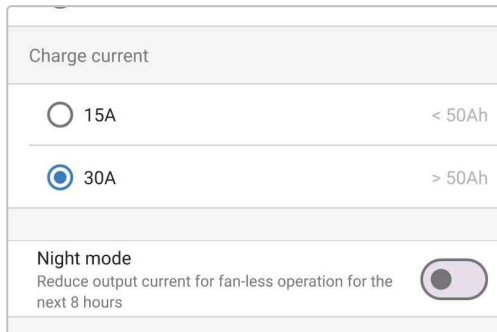

11. Lock Mode Button - When enabled, the mode button is locked and cannot change the charger's configuration. However, the following functions still work:

- Restart charge cycle to Bulk
- Enable Night mode
- Reset Bluetooth

When locked, pressing or holding the button will cause all LEDs to flash to indicate the lock is active.

All settings are stored and will not be lost when the charger is disconnected from mains power or the battery.



To ensure proper charging, battery longevity and safe operation it is important to select a charge mode appropriate for the battery type and capacity being charged; refer to the 'Operation > Charge modes' section and the battery manufacturers recommendations for more information.

6.3. Bluetooth

6.3.1. Changing the PIN code

To prevent unauthorised Bluetooth connections, it is highly recommended to change the default PIN code to a unique PIN code that offers a greater level of security.

The Bluetooth PIN code can be changed using a Bluetooth enabled device (mobile phone or tablet) with the **VictronConnect** app.

To change the Bluetooth PIN code:

1. Connect the **Blue Smart IP22 Charger** AC power cable to a mains power outlet; after a short delay the LEDs indicating the current charge mode and charge state will illuminate.

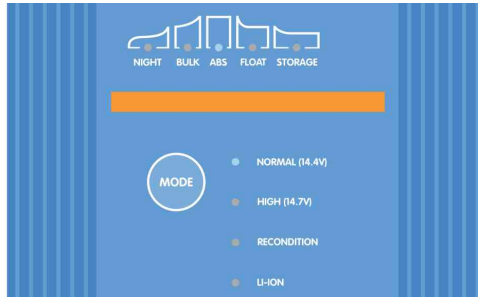

2. Using a Bluetooth enabled device (mobile phone or tablet), open the **VictronConnect** app and locate the **Blue Smart IP22 Charger** in the Device list Local page, then connect to the device (the default PIN code is stated on a label located on the back of the charger, or try 000000 if there is no label).

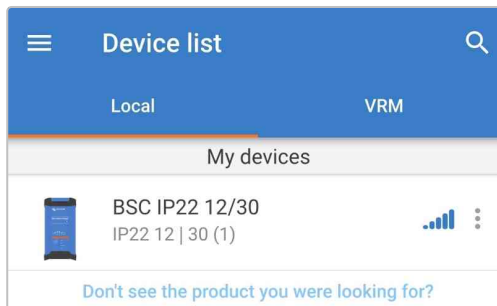

3. Select the **Settings** icon (gear in the top right corner) to access the Settings page.



4. Select the **Device options** icon (three vertical dots in the top right corner) to access the Device options dropdown menu.



5. Select **Product info** from the dropdown menu to access the Product info page.

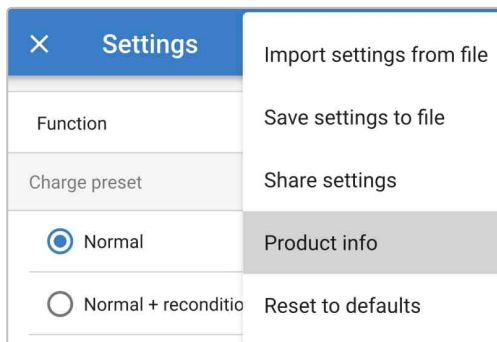

6. Select **CHANGE** in the Pin code field to open the Change PIN code pop-up dialog box.

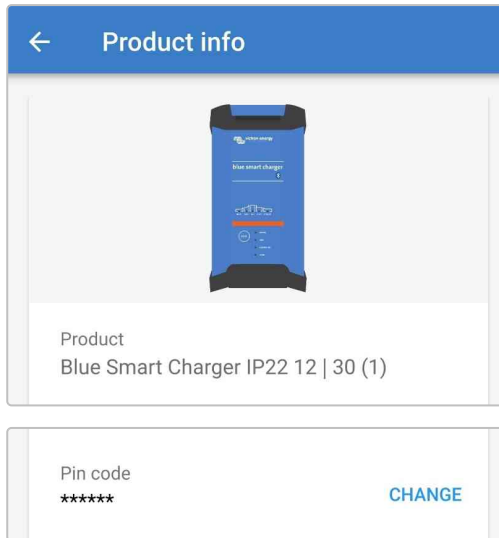

7. Enter the current PIN code and the desired new PIN code (twice), then select **OK**; avoid using a simple PIN code that is easy for someone else to guess, such as 123456.

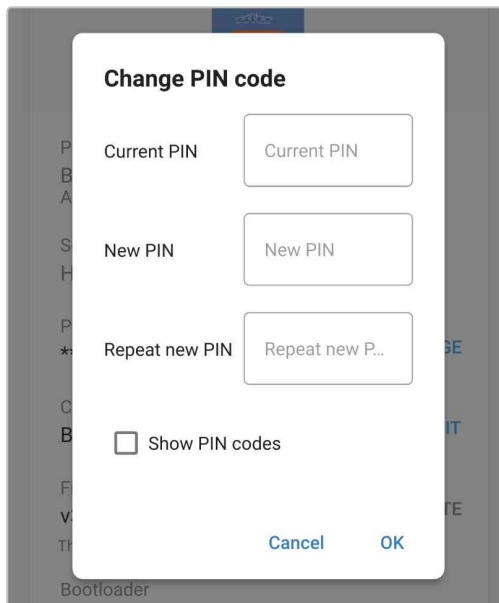

8. After a short delay a pop-up dialog box will appear confirming that the Bluetooth PIN code has been successfully changed.

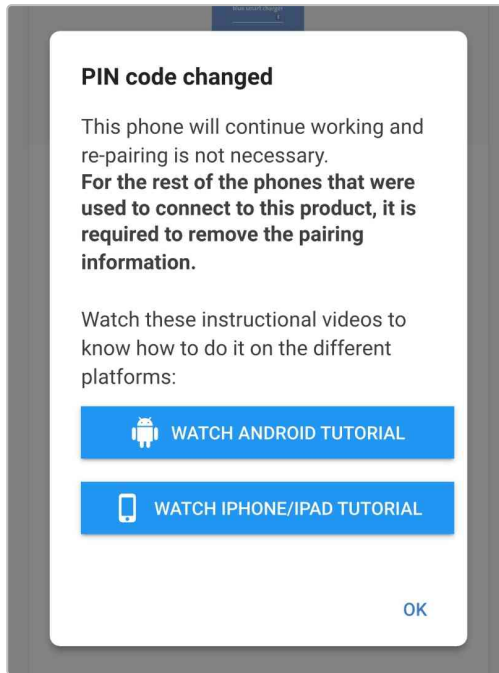

9. The Bluetooth PIN code has now been changed to the new PIN code.



During this procedure:

- A. The Bluetooth PIN code is changed to the new PIN code
- B. Bluetooth pairing information is not cleared

Accordingly Bluetooth pairing with the device (mobile phone or tablet) used to change the PIN code is unaffected, however it is necessary to unpair any other devices (mobile phones or tablets) previously paired with the **Blue Smart IP22 Charger** and establish a new Bluetooth pairing.

6.3.2. Resetting the PIN code

If the PIN code is forgotten/lost or does not work, it can be reset to 000000 (not the default PIN code stated on the label) using the MODE button on the charger or a Bluetooth enabled device (mobile phone or tablet) with the **VictronConnect** app.

Reset PIN using the charger

To reset the Bluetooth PIN code:

1. Connect the **Blue Smart IP22 Charger** AC power cable to a mains power outlet; after a short delay the LEDs indicating the current charge mode and charge state will illuminate.

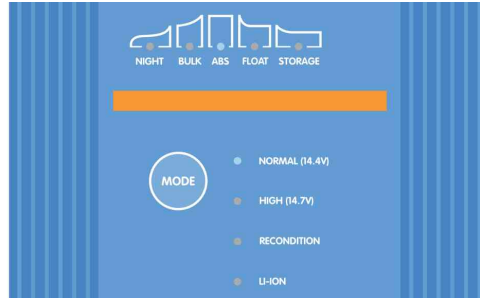

2. Depress and hold down the MODE button on the **Blue Smart IP22 Charger** for 10 seconds.



3. After 10 seconds have elapsed all charge mode LEDs will blink twice to indicate that the Bluetooth PIN code has been successfully reset.



4. The Bluetooth PIN code has now been reset to 000000.



During this procedure:

- A. The Bluetooth PIN code is reset to 000000 (not the default PIN code stated on the label)
- B. Bluetooth pairing information is cleared

Accordingly it is necessary to unpair all devices (mobile phones or tablets) previously paired with the **Blue Smart IP22 Charger** and establish a new Bluetooth pairing.

Reset PIN using VictronConnect

To reset the Bluetooth PIN code:

1. Locate the PUK code stated on a label located on the back of the charger and record it for use later.
2. Connect the **Blue Smart IP22 Charger** AC power cable to a mains power outlet; after a short delay the LEDs indicating the current charge mode and charge state will illuminate.

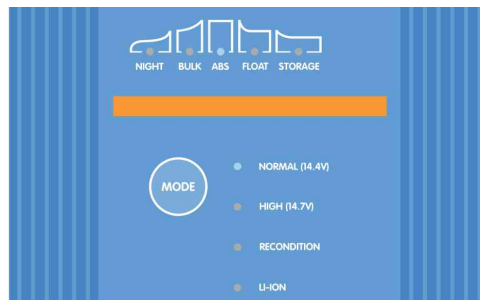

- Using a Bluetooth enabled device (mobile phone or tablet), open the **VictronConnect** app and locate the **Blue Smart IP22 Charger** in the Device list Local page.

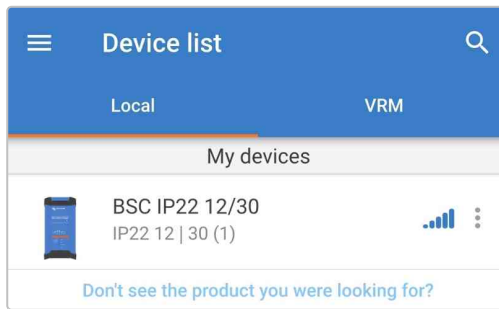

- Select the **Device options** icon (three vertical dots on the right side of the description) to access the dropdown menu.

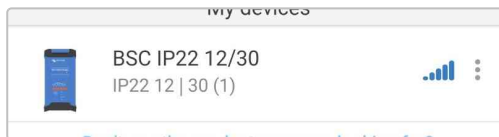

- Select **Reset PIN code** from the dropdown menu to open the Reset PIN code pop-up dialog box.

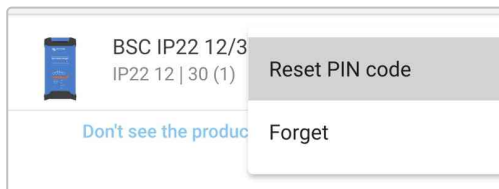

- Enter the PUK code (recorded earlier) and select **OK**.

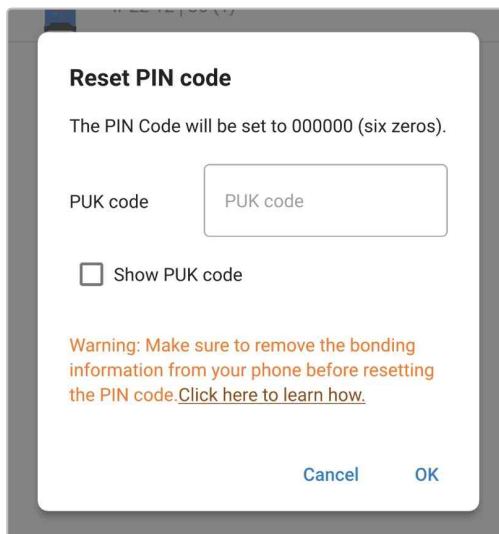

7. A pop-up dialog box with the text "Busy" will be displayed while the Bluetooth PIN code is being reset.

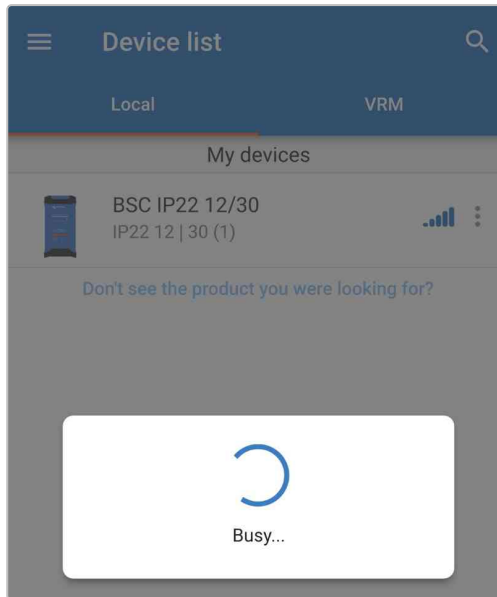

8. After a short delay a pop-up dialog box will appear confirming that the Bluetooth PIN code has been successfully reset; select **OK** to exit into the **VictronConnect** Device list LOCAL page.

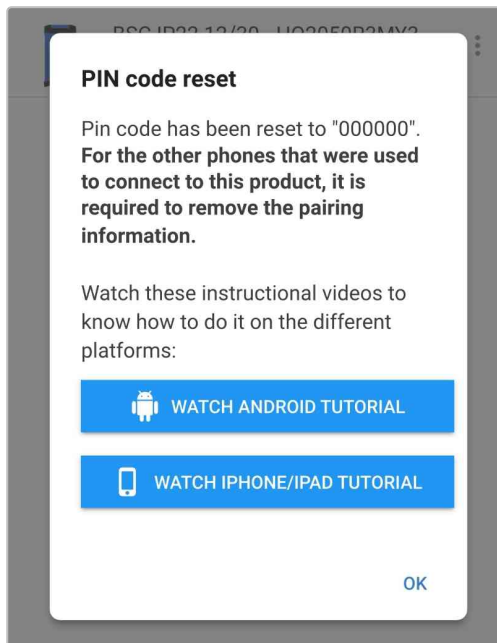

9. The Bluetooth PIN code has now been reset to 000000.

i **During this procedure:**

- A. The Bluetooth PIN code is reset to 000000 (not the default PIN code stated on the label)
- B. Bluetooth pairing information is not cleared

Accordingly Bluetooth pairing with the device (mobile phone or tablet) used to reset the PIN code is unaffected, however it is necessary to unpair any other devices (mobile phones or tablets) previously paired with the **Blue Smart IP22 Charger** and establish a new Bluetooth pairing.

6.3.3. Disabling Bluetooth

If required, Bluetooth communication can be totally disabled using a Bluetooth enabled device (mobile phone or tablet) with the **VictronConnect** app.

Typically, there is no need to disable Bluetooth since unauthorised access is protected with a PIN code, but certain situations may warrant it for an even higher level of security or in highly specialised installations where the Bluetooth radio frequency is undesirable.

To disable Bluetooth:

1. Connect the **Blue Smart IP22 Charger** AC power cable to a mains power outlet; after a short delay the LEDs indicating the current charge mode and charge state will illuminate.

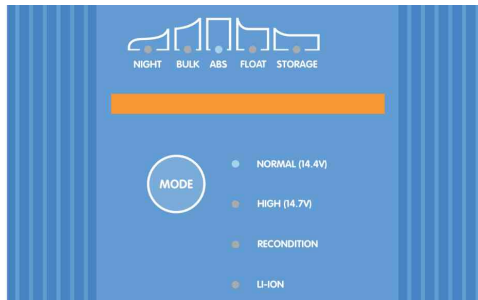

2. Using a Bluetooth enabled device (mobile phone or tablet), open the **VictronConnect** app and locate the **Blue Smart IP22 Charger** in the Device list Local page, then connect to the device (the default PIN code is stated on a label located on the back of the charger, or try 000000 if there is no label).

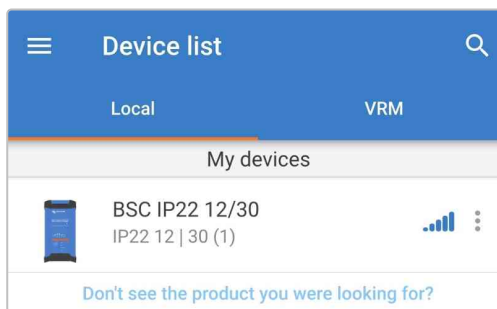

3. Select the **Settings** icon (gear in the top right corner) to access the Settings page.



4. Select the **Device options** icon (three vertical dots in the top right corner) to access the Device options dropdown menu.



5. Select **Product info** from the dropdown menu to access the Product info page.

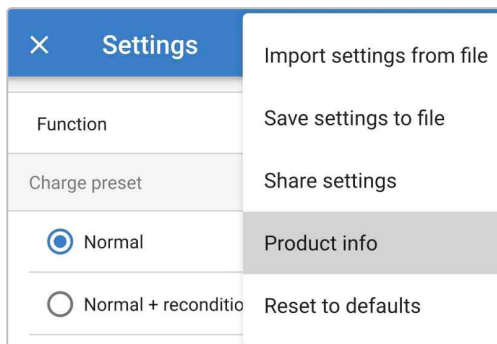

6. Select **DISABLE** in the Bluetooth field to open the Disable Bluetooth pop-up dialog box.

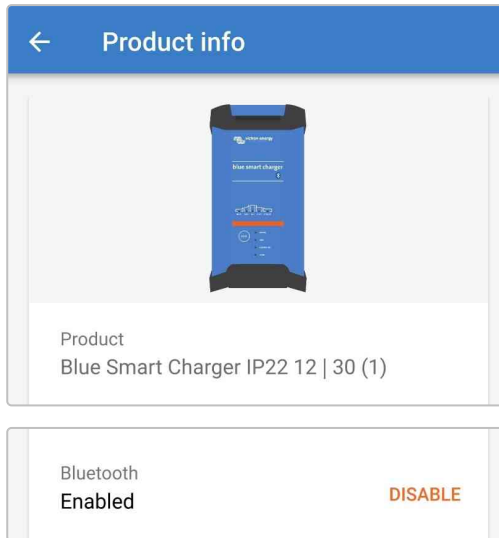

7. Read the warning message, then tick the checkbox and select **OK** to proceed.

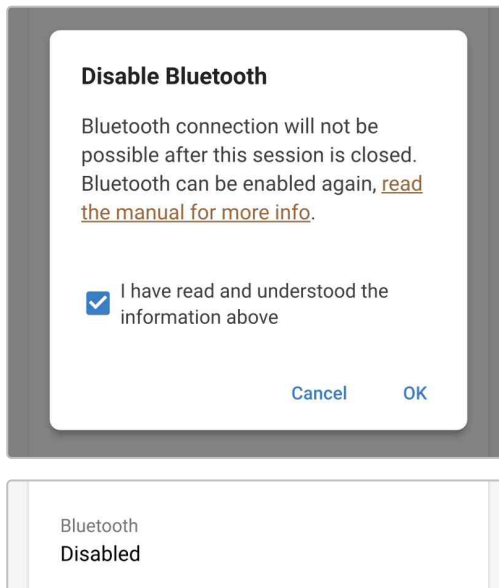

8. End the current Bluetooth session by exiting into the **VictronConnect** Device list Local page, a final pop-up dialog box will appear when attempting to exit. Read the warning message, then select **OK** to proceed.

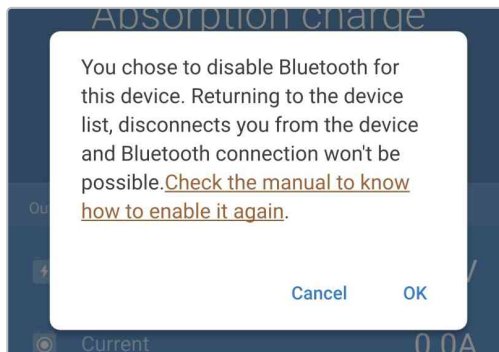

9. Bluetooth operation has now been disabled, but can be re-enabled again.

6.3.4. Re-enabling Bluetooth

Bluetooth communication can be re-enabled using the MODE button on the charger.

To re-enable Bluetooth:

1. Connect the **Blue Smart IP22 Charger** AC power cable to a mains power outlet; after a short delay the LEDs indicating the current charge mode and charge state will illuminate.



2. Depress and hold down the **MODE** button on the **Blue Smart IP22 Charger** for 10 seconds.



3. After 10 seconds have elapsed all charge mode LEDs will blink twice to indicate that Bluetooth operation has been successfully enabled.



4. Bluetooth operation has now been re-enabled.



During this procedure:

- A. Bluetooth operation is re-enabled
- B. The Bluetooth PIN code is reset to 000000 (not the default PIN code stated on the label)
- C. Bluetooth pairing information is cleared

Accordingly it is necessary to unpair all devices (mobile phones or tablets) previously paired with the **Blue Smart IP22 Charger** and establish a new Bluetooth pairing.

6.4. Updating firmware

6.4.1. Automated firmware update

The **Blue Smart IP22 Charger** firmware can be automatically updated using a Bluetooth enabled device (mobile phone or tablet) with the **VictronConnect** app.

The latest product firmware is embedded within the **VictronConnect** app and loaded to the Bluetooth enabled device (mobile phone or tablet) when the **VictronConnect** app is installed/updated, accordingly the **VictronConnect** app will include the latest product Firmware as long as it is kept up to date, and no internet connection is required during the firmware update process.

Settings and operational history are preserved during a firmware update; no additional re-configuration is necessary after completion of a firmware update.

There are two levels of automated firmware update:

- A. **Optional:** The new firmware update is optional, but recommended to obtain the latest improvements and features.
- B. **Mandatory:** The new firmware update is mandatory, typically because the new firmware contains a critical improvement or operational fix. Settings will be locked and inaccessible until the firmware is updated.

To update firmware automatically:

1. Connect the **Blue Smart IP22 Charger** AC power cable to a mains power outlet; after a short delay the LEDs indicating the current charge mode and charge state will illuminate.

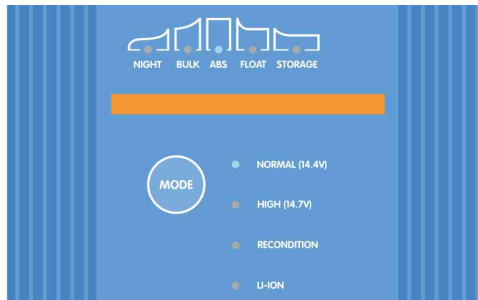

2. Using a Bluetooth enabled device (mobile phone or tablet), open the **VictronConnect** app and locate the **Blue Smart IP22 Charger** in the Device list Local page, then connect to the device (the default PIN code is stated on a label located on the back of the charger, or try 000000 if there is no label).

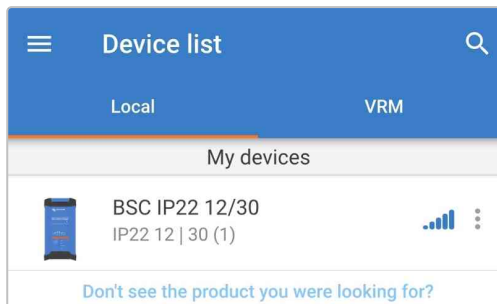

3. When a firmware update is available, notification is provided via an exclamation mark within an orange circle positioned over the Setting icon (gear in the top right corner); select the **Settings** icon to access the Settings page.



4. Refer to the dialog box at the top of the Settings page to determine the level/urgency of the firmware update available, then select **UPDATE** to access the Firmware update page.

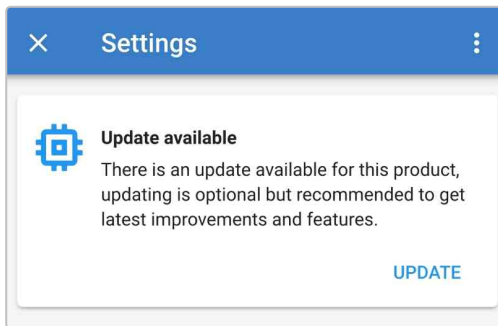

5. Refer to the current and new firmware versions stated at the top of the Firmware update page, then select **Update** to proceed.



- The firmware update will commence and a progress bar will be displayed within the Firmware update page.
Ensure that the Bluetooth enabled device (mobile phone or tablet) remains close to the **Blue Smart IP22 Charger** until the firmware update is complete and avoid using the device during this period; be patient as the firmware update may take several minutes to complete.

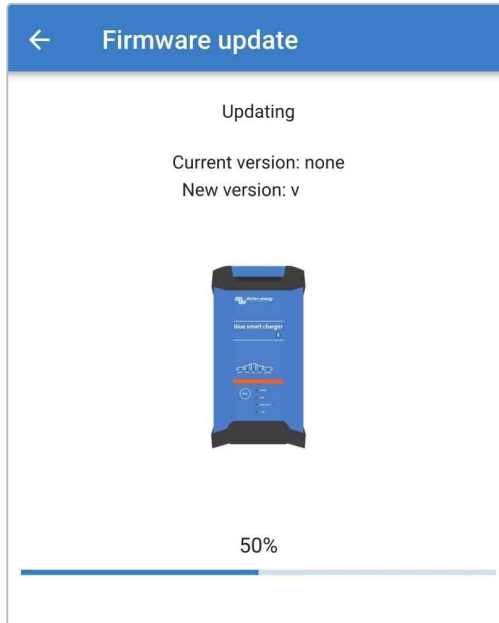

- If the firmware update does fail for some reason, a notification with the failure reason will be provided within the Firmware update page; select **Continue** to exit into the **VictronConnect** Device list Local page and re-attempt the firmware update.

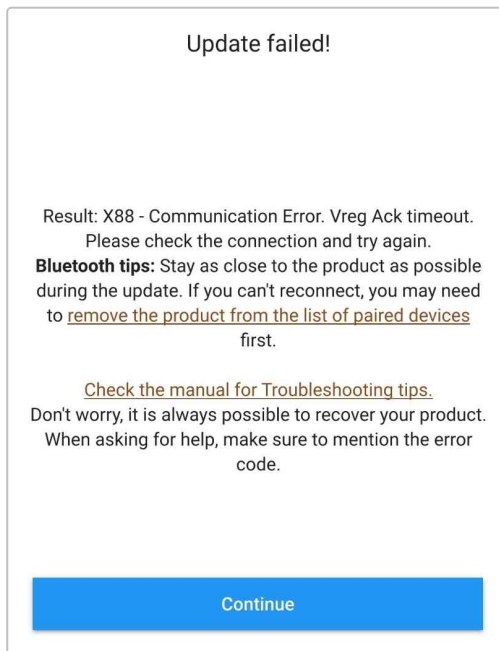

- Confirmation that the firmware has been successfully updated and the new firmware version will be provided within the Firmware update page when the firmware update is complete; select **Continue** to exit into the **VictronConnect** Device list Local page.

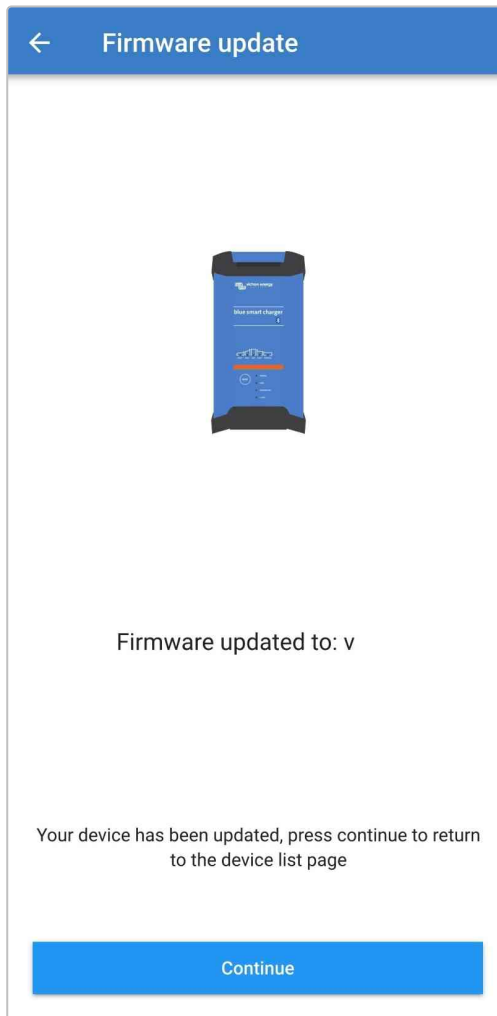

- The firmware has now been updated.

6.4.2. Manual firmware update

Updating firmware manually is typically not required but there are some rare circumstances when it may be necessary, such as:

- A. Updating to a new firmware version that has just been released and is available for download via the [Victron Professional Portal](#), but not included in the **VictronConnect** app version currently available; alternatively wait for the next **VictronConnect** app version to be released
- B. Updating to an unreleased beta firmware version for testing purposes
- C. Updating to an unreleased special firmware version provided by Victron
- D. Downgrading to an older firmware version, typically for troubleshooting/comparative purposes

To update firmware manually:

1. Using a Bluetooth enabled device (mobile phone or tablet) with the **VictronConnect** app installed, access the required firmware file (.xup file extension) via a file browser, file hosting service/application, collaboration service/application, or email service/application and directly open the file (if prompted, select **Open with VictronConnect**).
2. After a short delay the **VictronConnect** app will automatically open and then a pop-up dialog box will appear confirming that the firmware file has been successfully loaded into the Firmware library; if the **VictronConnect** app does not open and/or the pop-up dialog box does not appear try a different method to access the file.

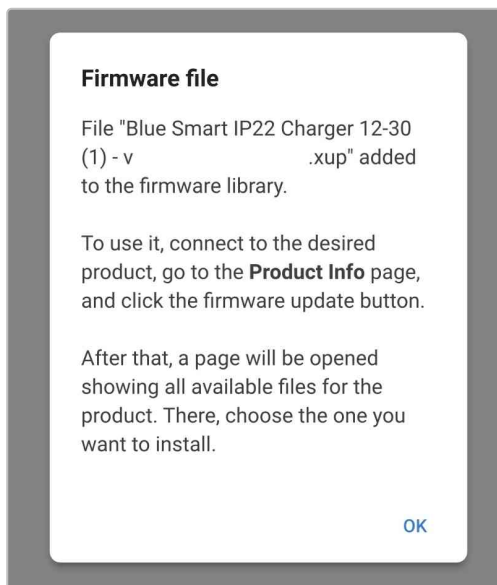

3. Connect the **Blue Smart IP22 Charger** AC power cable to a mains power outlet; after a short delay the LEDs indicating the current charge mode and charge state will illuminate.

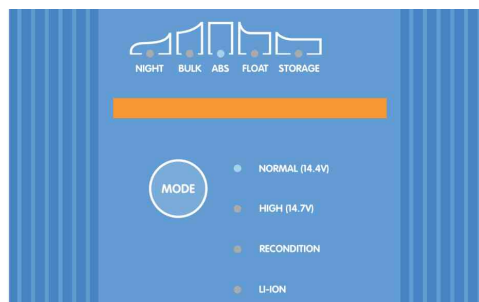

Blue Smart IP22 Charger

- Using the same Bluetooth enabled device (mobile phone or tablet), open the **VictronConnect** app (if not already open) and locate the **Blue Smart IP22 Charger** in the Device list Local page, then connect to the device (the default PIN code is stated on a label located on the back of the charger, or try 000000 if there is no label).

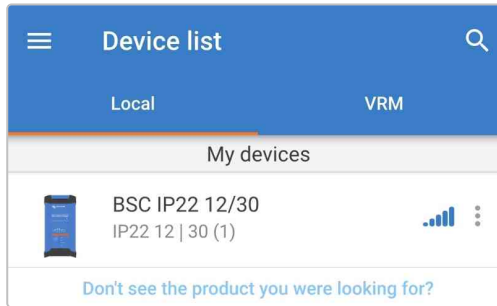

- Select the **Settings** icon (gear in the top right corner) to access the Settings page.



- Select the **Device options** icon (three vertical dots in the top right corner) to access the Device options dropdown menu.



- Select **Product info** from the dropdown menu to access the Product info page.

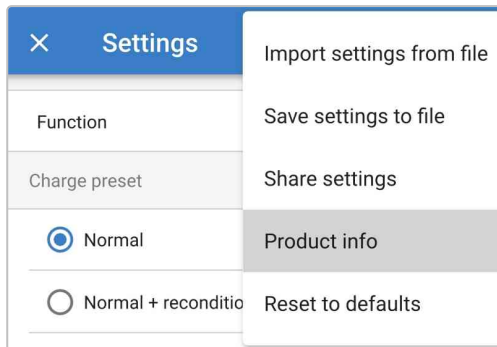

- Select **MANUAL UPDATE** in the Firmware field to open the Firmware library page.

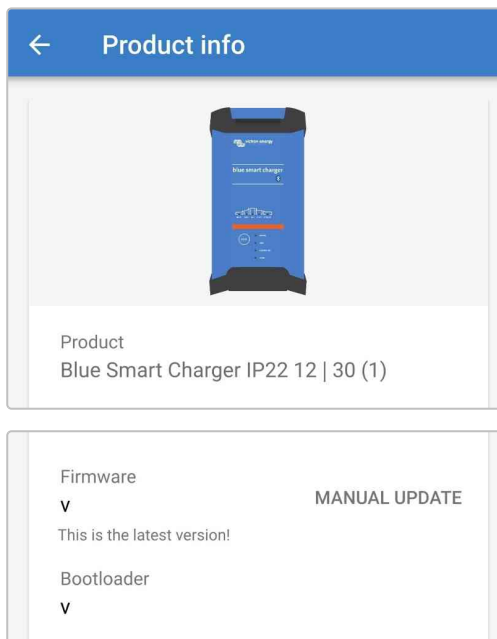

- 9. Select the **Blue Smart IP22 Charger** firmware file that has just been manually loaded from the the Firmware library page (if multiple firmware versions have been manually loaded, ensure the correct version is selected) to access the Firmware update page.

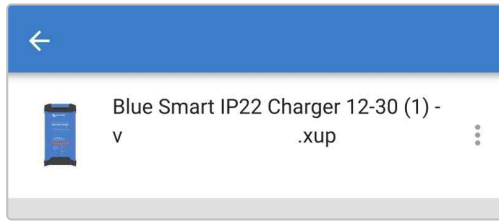

- 10. If no firmware files are listed within the the Firmware library page, the Firmware file previously loaded is likely not compatible with the specific **Blue Smart IP22 Charger** model or hardware version being updated.

Due to this mechanism it is not possible to update with a non-compatible firmware file; if there is uncertainty about which firmware file is correct for the specific **Blue Smart IP22 Charger** model being updated, multiple firmware files can be safely loaded.

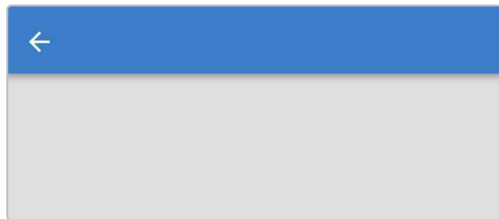

- 11. Refer to the current and new firmware versions stated at the top of the Firmware update page, then select **Update** to proceed.



12. The firmware update will commence and a progress bar will be displayed within the Firmware update page. Ensure that the Bluetooth enabled device (mobile phone or tablet) remains close to the **Blue Smart IP22 Charger** until the firmware update is complete and avoid using the device during this period; be patient as the firmware update may take several minutes to complete.

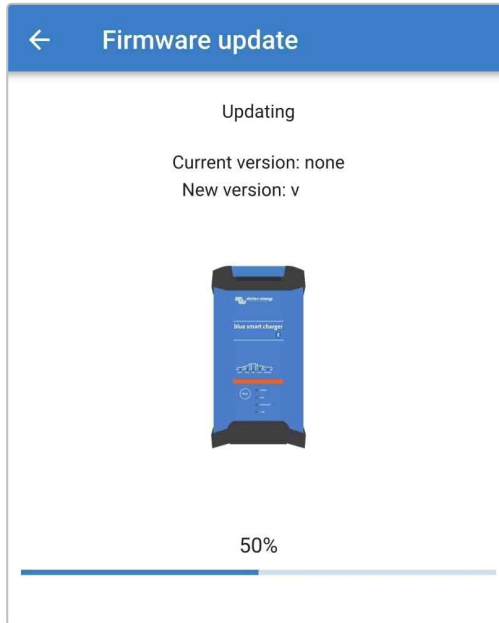

13. If the firmware update does fail for some reason, a notification with the failure reason will be provided within the Firmware update page; select **Continue** to exit into the **VictronConnect** Device list Local page and re-attempt the firmware update.

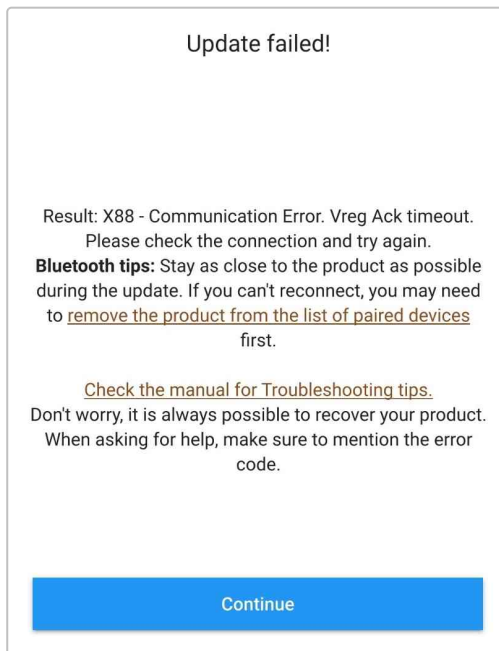

- Confirmation that the firmware has been successfully updated and the new firmware version will be provided within the Firmware update page when the firmware update is complete; select **Continue** to exit into the **VictronConnect** Device list Local page.

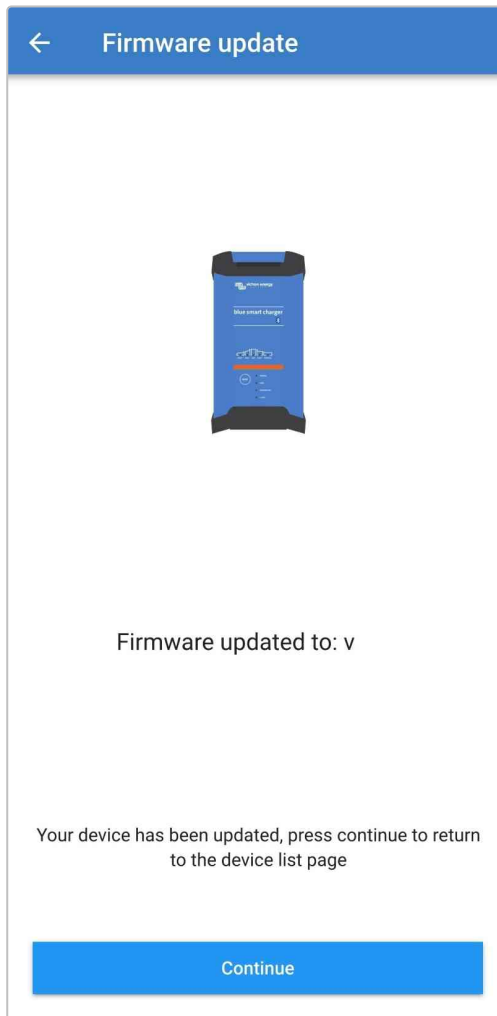

- The firmware has now been updated.

6.5. Reset to defaults

If required, all **Blue Smart IP22 Charger** settings can be reset/restored to factory defaults using a Bluetooth enabled device (mobile phone or tablet) with the **VictronConnect** app.

Note this operation does **not** reset any Bluetooth related settings, such as the Bluetooth PIN code or pairing information.

To reset all settings to factory defaults:

1. Connect the **Blue Smart IP22 Charger** AC power cable to a mains power outlet; after a short delay the LEDs indicating the current charge mode and charge state will illuminate.

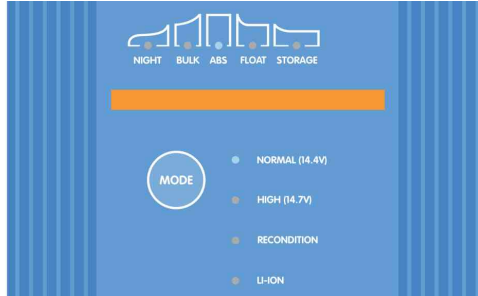

2. Using a Bluetooth enabled device (mobile phone or tablet), open the **VictronConnect** app and locate the **Blue Smart IP22 Charger** in the Device list Local page, then connect to the device (the default PIN code is stated on a label located on the back of the charger, or try 000000 if there is no label).

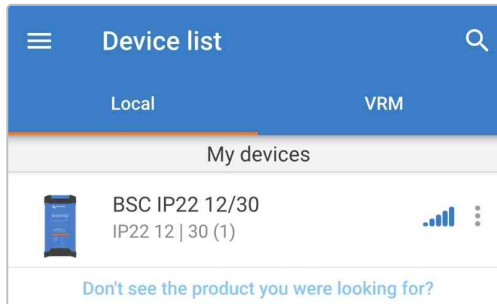

3. Select the **Settings** icon (gear in the top right corner) to access the Settings page.



4. Select the **Device options** icon (three vertical dots in the top right corner) to access the Device options dropdown menu.



5. Select **Reset to defaults** from the dropdown menu to open the Restore device pop-up dialog box.

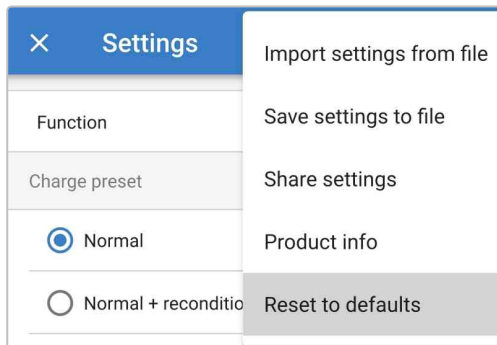

6. Read the warning message, then select **Yes** to proceed.

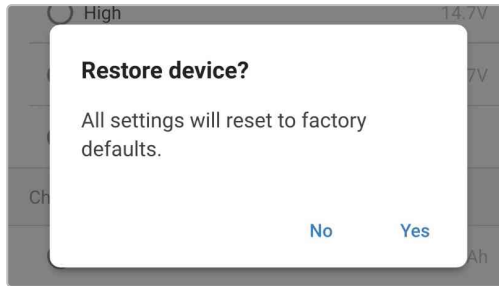

7. All settings have now been reset/restored to factory defaults.

7. Monitoring

7.1. LED indications

7.1.1. Operation states

The LEDs on the **Blue Smart IP22 Charger** unit can be referenced to determine the current charge state and other operational information.



Refer to the LED indications in the table below:

Operation state	NIGHT	BULK	ABS	FLOAT	STORAGE
Bulk	N/A	Illuminated	Off	Off	Off
Absorption	N/A	Off	Illuminated	Off	Off
Recondition *1	N/A	Off	Illuminated	Off	Off
Float	N/A	Off	Off	Illuminated	Off
Storage	N/A	Off	Off	Off	Illuminated
Power supply mode	N/A	Illuminated	Illuminated	Illuminated	Illuminated
Low current mode	Blinking	N/A	N/A	N/A	N/A
Night mode	Illuminated	N/A	N/A	N/A	N/A
Error *2	N/A	Blinking	Blinking	Blinking	Blinking
VE.Smart networking	N/A	Active charge state LED will blink (turn off) momentarily every 4s			



*1 The RECONDITION LED will also blink during recondition stage.

*2 Use a Bluetooth enabled device (mobile phone or tablet) with the **VictronConnect** app to determine the specific error code.

7.2. VictronConnect

The **Blue Smart IP22 Charger** operation can be monitored in real-time and/or after completion of a charge cycle using a Bluetooth enabled device (mobile phone or tablet) with the **VictronConnect** app; this includes live data such as charger output voltage, output current, the current charge stage, charge cycle statistics, warnings, alarms and errors.

When a Bluetooth connection is established with the charger, detailed data is available across three different overview screens available (STATUS, GRAPH and HISTORY), each displaying different monitoring or historical data spanning back over the last 40 charge cycles; the desired screen can be selected by either selecting the related title or by swiping between screens.

It is also possible to view and monitor key data and notifications directly in the **VictronConnect** Device list Local page without connecting to the charger, via Instant readout functionality.

7.2.1. Status screen

The Status screen is the main overview screen; it displays the function mode (charger or power supply), the active charge state (in charger mode), the battery voltage and the charge/output current.

This data will update continuously in real time as the charge cycle progresses.

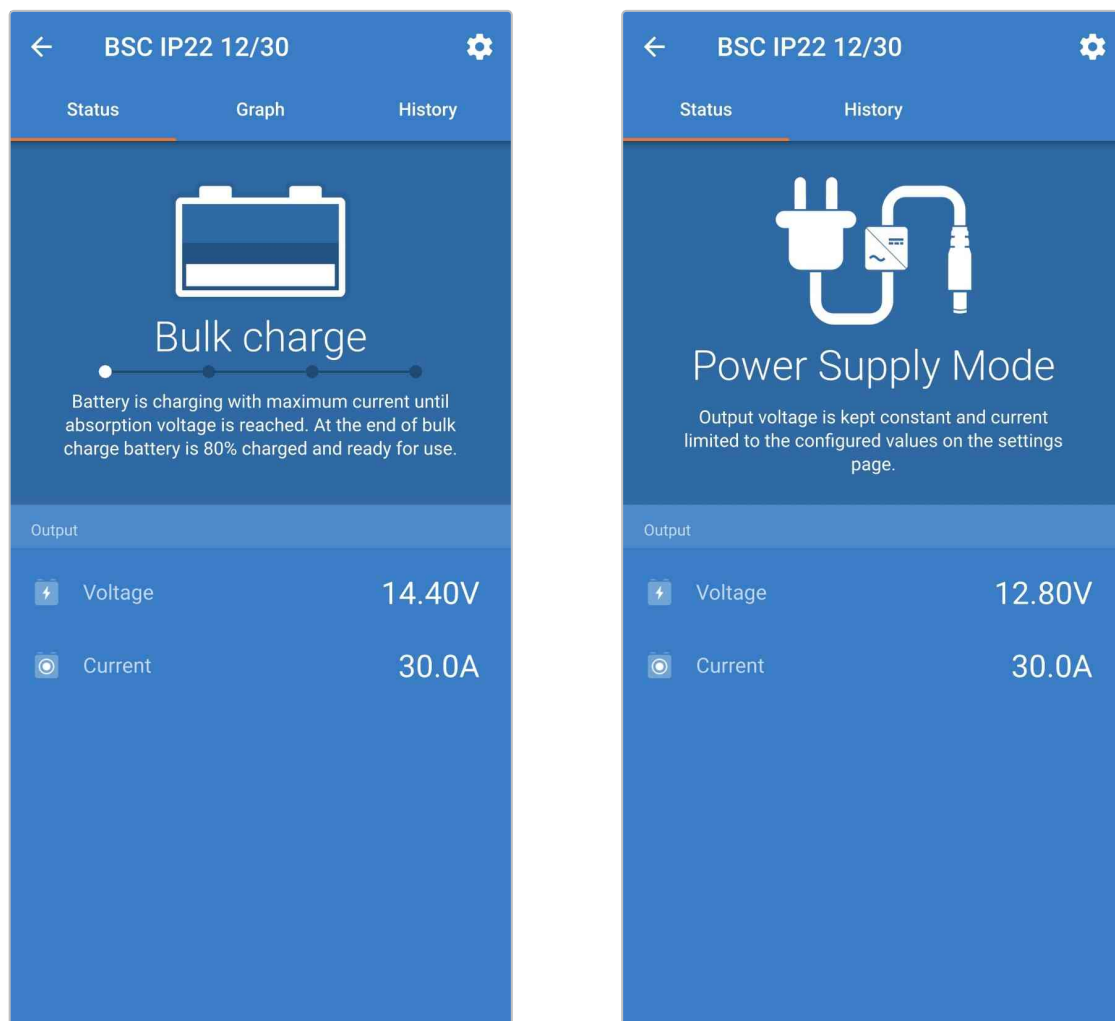

7.2.2. Graph screen

The Graph screen provides an easy to understand graphical representation of each charge state with respect to typical battery voltage and charge current.

The active charge stage is also highlighted and stated, along with a brief explanation.

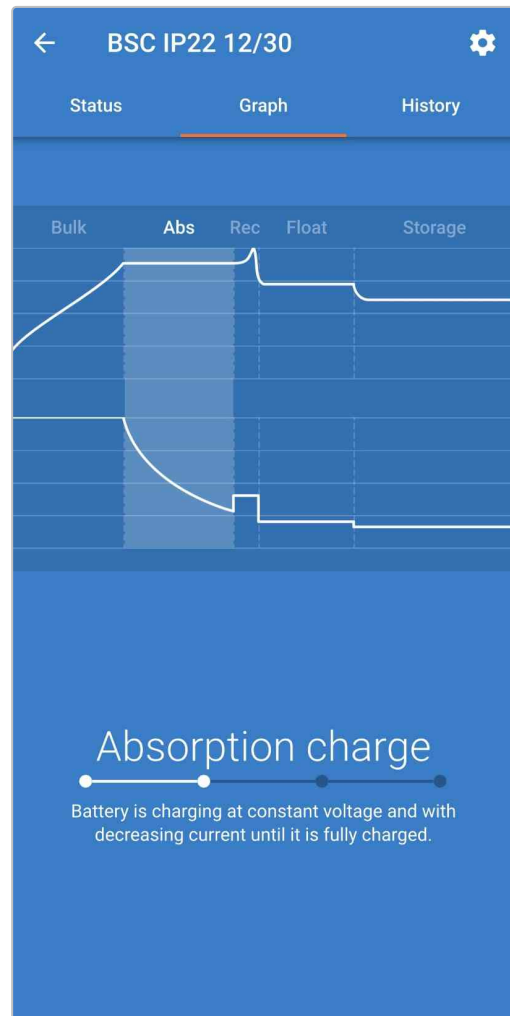
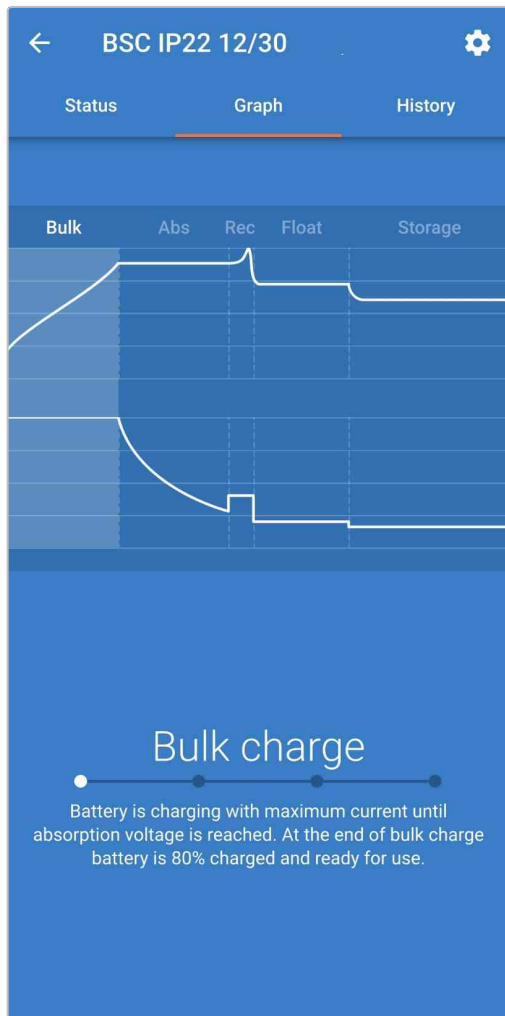

7.2.3. History screen

The History screen is a very powerful reference as it contains historical usage data over the charger lifetime and detailed statistics for the last 40 charge cycles (even if the charge cycle is only partially completed).

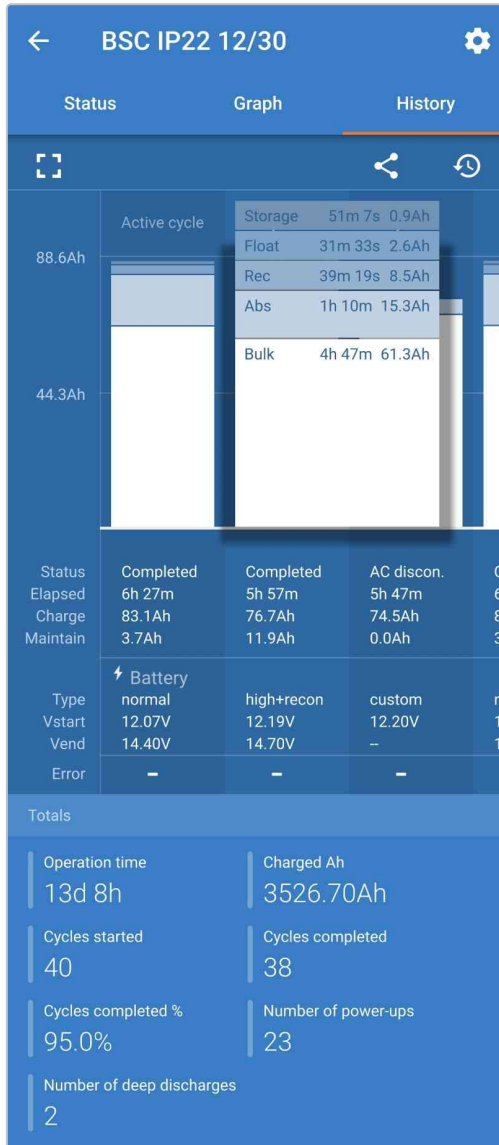

By selecting the full screen view the data is displayed in landscape view with significantly more days visible at the same time.

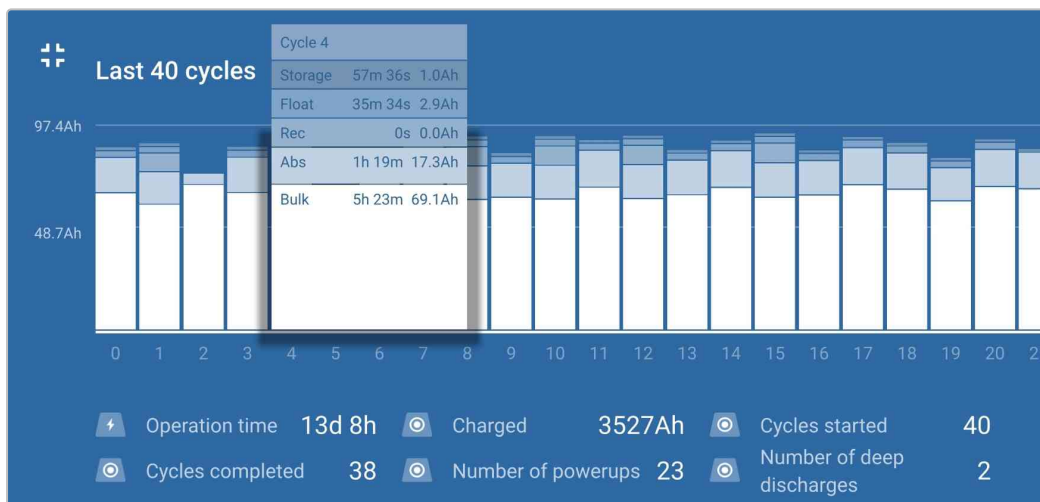

Charge cycle statistics

A. Cycle overview

Expandable bar chart showing the time spent in each charge stage and the charge capacity provided (in Ah) during each charge stage

B. Status

Confirms if the charge cycle was successfully completed or if it was ended early/interrupted, including the reason/cause

C. Elapsed

The elapsed time of the recharge stages (Bulk and Absorption)

D. Charge

Total capacity provided during the recharge stages (Bulk and Absorption)

E. Maintain

Total capacity provided during the charge maintenance stages (Float, Storage and Recondition)

F. Type

The charge cycle mode used; either a Built-in preset mode or a custom User defined configuration

G. Vstart

Battery voltage when charging commences

H. Vend

Battery voltage when charging is complete (end of absorption stage)

I. Error

Displays if any errors occurred during the charge cycle, including the error number and description

Charger lifetime statistics

A. Operation time

The total operation time over the lifetime of the charger

B. Charged Ah

The total charge capacity (in Ah) provided over the lifetime of the charger

C. Cycles started

The total charge cycles started over the lifetime of the charger

D. Cycles completed

The total charge cycles completed over the lifetime of the charger

E. Cycles completed %

The percentage of charge cycles completed over the lifetime of the charger

F. Number of power-ups

The number of times the charger has been powered up over the lifetime of the charger

G. Number of deep discharges

The number of times the charger has recharged a deeply discharged battery over the lifetime of the charger

7.3. Instant readout

The **Blue Smart IP22 Charger** range features instant readout functionality (requires firmware v3.61 or above), which enables the essential data and notifications from multiple compatible devices to be monitored directly in the **VictronConnect** device list, without the need to establish a full Bluetooth connection with the device.

The key benefits of instant readout over a traditional full Bluetooth connection are:

- All essential data is displayed within the instant readout, making it unnecessary to establish a full Bluetooth connection for most monitoring requirements
- Faster and easier means to monitor essential data, as there is no need to establish a full Bluetooth connection and navigate between screens
- Data from multiple compatible devices can be simultaneously monitored in real-time and compared on a single screen, eliminating the need to connect to multiple devices in succession and try to remember data
- Instant readout transmission range is longer than a full Bluetooth connection, since there is only one way encrypted data transmission, as opposed to two way communication

The **Blue Smart IP22 Charger** will display the following data directly in the **VictronConnect** device list via instant readout:

- Output voltage
- Output current
- Charge stage
- Warning and alarm notifications
- Error notifications

Instant readout transmission is disabled by default, and can be enable using a Bluetooth enabled device (mobile phone or tablet) with the **VictronConnect** app.

To enable instant readout:

- Connect the **Blue Smart IP22 Charger** AC power cable to a mains power outlet; after a short delay the LEDs indicating the current charge mode and charge state will illuminate.

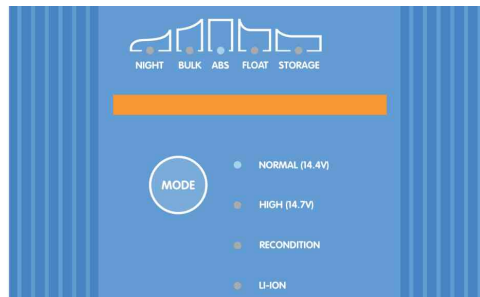

- Using a Bluetooth enabled device (mobile phone or tablet), open the **VictronConnect** app and locate the **Blue Smart IP22 Charger** in the Device list Local page, then connect to the device (the default PIN code is stated on a label located on the back of the charger, or try 000000 if there is no label).

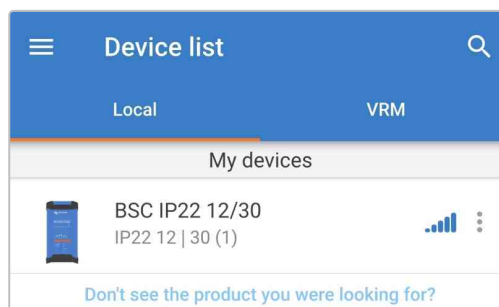

3. After a short delay the Instant readout pop-up dialog box will appear:
 - A. When the Instant readout pop-up dialog box appears, select **Enable now** to enable instant readout functionality; skip to step 9.
 - B. If the Instant readout pop-up dialog box does not appear, the automated prompt may have been disabled or the charger firmware does not support instant readout and needs to be updated (instant readout requires firmware v3.61 or above); continue to step 4.

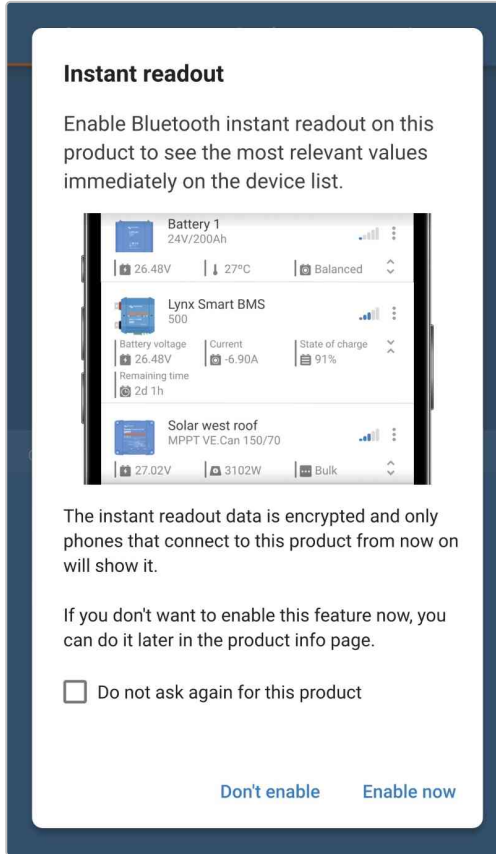

4. Select the **Settings** icon (gear in the top right corner) to access the Settings page.



5. Select the **Device options** icon (three vertical dots in the top right corner) to access the Device options dropdown menu.



6. Select **Product info** from the dropdown menu to access the Product info page.

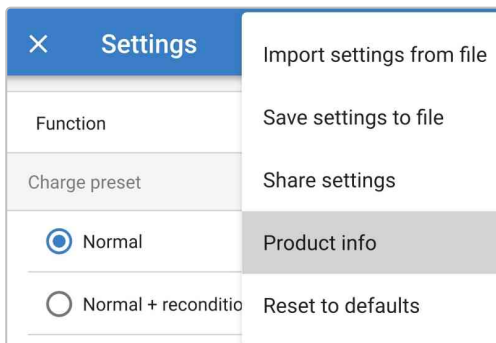

- 7. Confirm that the charger firmware version supports instant readout functionality:
 - A. If the current firmware version is v3.61 or above continue to step 8.
 - B. If the current firmware version is below v3.61, update to the latest firmware version and then repeat the entire process; refer to the 'Setup > Updating firmware' section for more information.

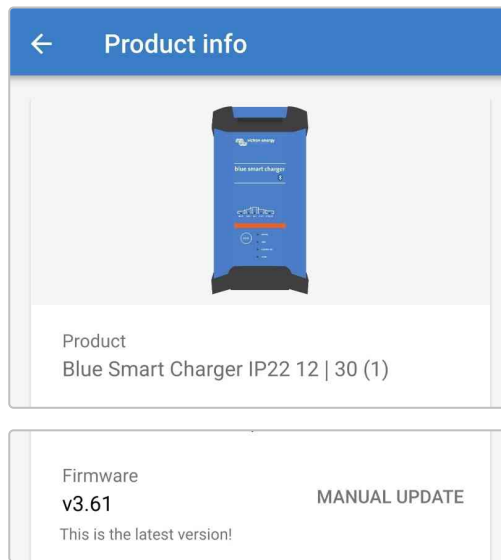

- 8. Toggle the **Instant readout via Bluetooth** switch on to enable instant readout functionality.

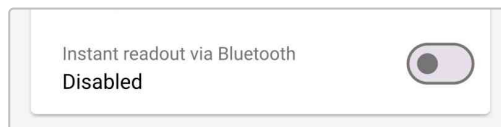

- 9. When instant readout is enabled, the Instant readout details field is displayed beneath the Instant readout via Bluetooth field.

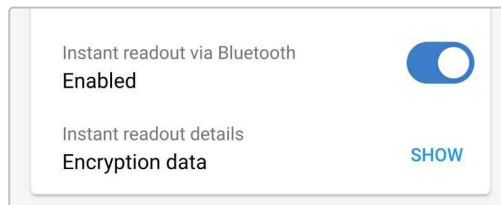

If the instant readout encryption data (MAC address and encryption key) is required, select **SHOW** from the Instant readout details field to open the Instant readout encryption data pop-up dialog; this data is **not** required for normal instant readout functionality via the **VictronConnect** app, it is only relevant for advanced integration of the instant readout data with third party Bluetooth devices and software.

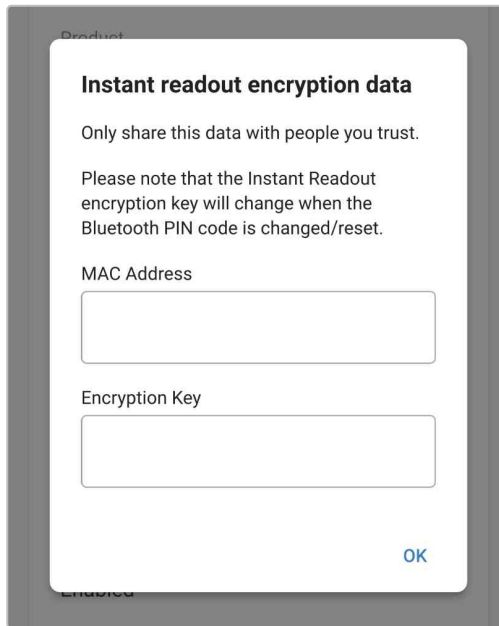

10. End the current Bluetooth session by exiting into the **VictronConnect** Device list Local page.
11. Instant readout has now been enabled; data descriptions and additional data (if available) can be displayed or hidden by toggling the opposing arrows icon (right of the instant data).

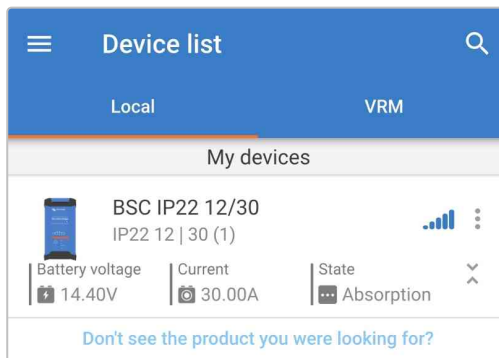

8. Advanced Configuration

8.1. Advanced settings

In specific use cases where the integrated charge modes are not suitable/ideal for the battery type being charged, or the battery manufacturer recommends specific charge parameters and fine tuning is desired, advanced configuration is possible using a Bluetooth enabled device (mobile phone or tablet) with the **VictronConnect** app.

For most common battery types, advanced configuration is not required or recommended; the integrated charge modes and adaptive charge logic are typically suitable and perform very well.

The advanced settings page enables specific configuration of charge parameters and user defined settings to be saved and easily selected.

Settings	
Battery preset	User defined ▾
Expert mode	<input checked="" type="checkbox"/>
Maximum charge current	30.0A
Charge voltage	
Absorption voltage	14.40V
Float voltage	13.80V
Storage voltage	13.20V
Recondition voltage	Disabled
<small>Increases the battery voltage while the current is below 2.4A</small>	
Voltage compensation	
Temperature compensation	-16.20mV/°C
Battery limits	
Low temperature cut-off	Disabled

To access the advanced settings:

1. Connect the **Blue Smart IP22 Charger** AC power cable to a mains power outlet; after a short delay the LEDs indicating the current charge mode and charge state will illuminate.

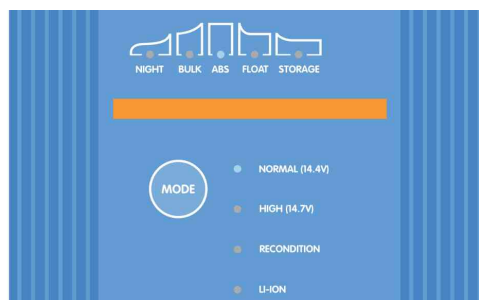

- Using a Bluetooth enabled device (mobile phone or tablet), open the **VictronConnect** app and locate the **Blue Smart IP22 Charger** in the Device list Local page, then connect to the device (the default PIN code is stated on a label located on the back of the charger, or try 000000 if there is no label).

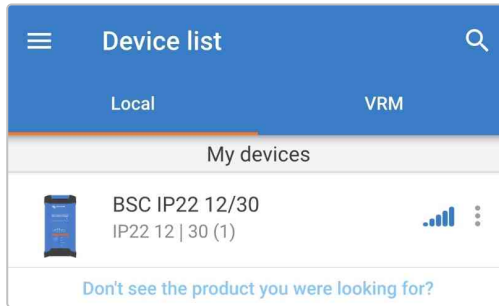

- Select the **Settings** icon (gear in the top right corner) to access the Settings page.



- Toggle the **Advanced settings** switch on to enable the Advanced settings page.

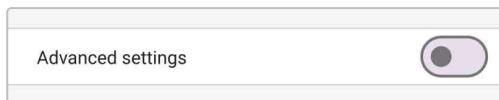

- Read the warning message and then select **OK** to proceed.

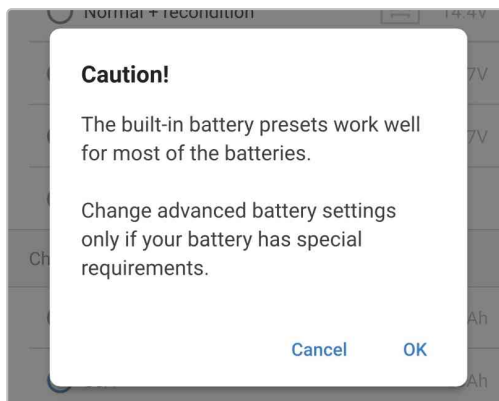

- Select **Advanced battery settings** to access the Advanced settings page.

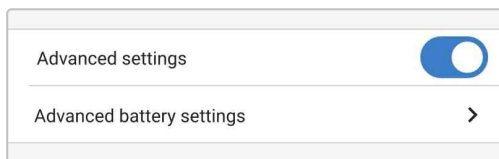

To configure user defined advanced settings:

- Select the **Battery preset** dropdown arrow to expand the dropdown menu.

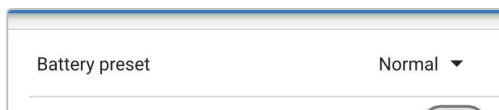

2. Select **User defined** from the Battery preset dropdown menu.

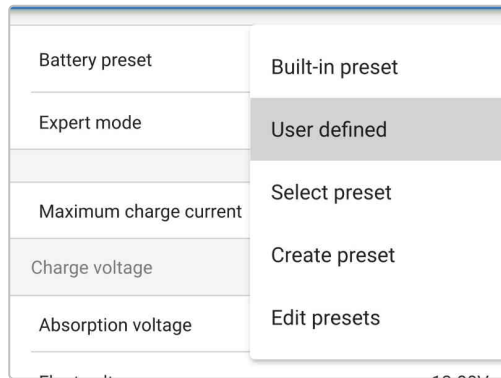

3. User defined configuration will now be enabled.

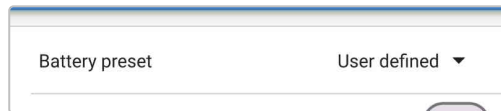

4. Configure the advanced settings as required per battery manufacturers recommendations.

The advanced settings (with expert mode disabled) include:

A. Battery preset

The Battery preset dropdown allows selection from the following options:

- i. **Built-in preset**
Selection of a standard integrated pre-set (same as the general settings menu)
- ii. **User defined**
Configuration of user defined charge settings and selection of the last user defined configuration
- iii. **Select preset**
Selection from an extended range of integrated battery charging pre-sets, including new user defined charging pre-sets
- iv. **Create preset**
A new charging preset to be created and saved from user defined settings
- v. **Edit presets**
An existing preset to be edited and saved

B. Maximum charge current

The maximum charge current setting allows selection between the default and a significantly reduced charge current limit preset; Maximum, Low (50% of maximum) or Minimum (25% of maximum) current. Alternatively a user defined maximum charge current (between the minimum and maximum limits) can be configured.

C. Charge voltage

The charge voltage settings enable the voltage setpoint for each charge stage to be independently configured and some charge stages (recondition and float) to be disabled or enabled.

The charge voltage setpoint can be configured for the following charge stages:

- i. **Absorption**
- ii. **Float**
- iii. **Storage**
- iv. **Recondition**

D. Voltage compensation

i. Temperature compensation

The temperature compensation setting enables the charge voltage temperature compensation coefficient to be configured, or temperature compensation to be totally disabled (such as for Li-ion batteries). The temperature compensation coefficient is specified in mV/°C and applies to the entire battery/battery bank (not per battery cell).

E. **Battery limits**

i. **Low temperature cut-off**

The low temperature cut-off setting disables charging in low temperature conditions to protect Lithium batteries from damage; this setting requires battery temperature to be provided by a compatible battery monitor via VE.Smart networking.

8.2. Expert mode settings

Expert mode expands the advanced settings menu even further, to include more specialised expert level configuration settings.

←
Settings

Battery preset
User defined ▾

Expert mode

Maximum charge current
30.0A

Charge voltage

Absorption voltage
14.40V

Float voltage
13.80V

Storage voltage
13.20V

Recondition voltage
Disabled

Increases the battery voltage while the current is below 2.4A

BatterySafe

Prevent excessive gassing by automatically limiting the rate of voltage increase.

Voltage compensation

Temperature compensation
-16.20mV/°C

Bulk

Bulk time limit
1d 0h

Re-bulk method
Constant current

Re-bulk voltage offset
0.10V

Re-bulk current
Disabled

When the charge current exceeds this value while in float/storage, the charge cycle restarts.

Absorption

Absorption duration
Adaptive

Maximum absorption time
8h 0m

Tail current
Disabled

Repeated absorption
Every 7 days

Recondition

Recondition current percentage
8%

Recondition stop mode
Automatic, on voltage

Maximum recondition duration
1h 0m

Manual recondition
Start now

Battery limits

Low temperature cut-off
Disabled

To access the expert mode settings:

1. Open the **Advanced setting** page and enable **User defined** configuration - see the 'Advanced configuration > Advanced settings' section for instructions.
2. Toggle the **Expert mode** switch on to enable additional Expert mode settings (extension of the Advanced settings menu).

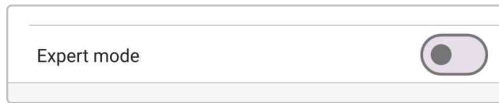

3. Read the warning message and then select **OK** to proceed.

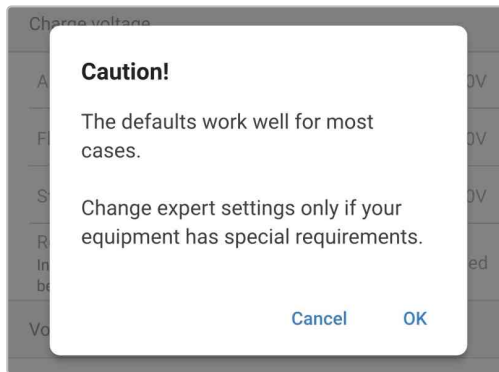

4. The Expert mode settings (extension of the Advanced settings menu) will now be accessible.

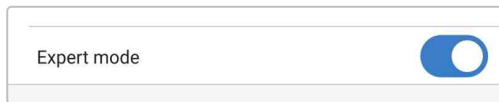

The ADDITIONAL expert mode settings include:

A. Charge voltage

i. BatterySafe

The BatterySafe setting allows the BatterySafe voltage control to be enabled or disabled. When BatterySafe is enabled, the rate of battery voltage increase during bulk stage is automatically restricted to a safe level. In cases where the battery voltage would otherwise increase at a faster rate, the charge current is reduced to prevent excessive gassing.

B. Bulk

i. Bulk time limit

The bulk time limit setting restricts the maximum time the charger can spend in bulk stage as a protection measure, since the absorption voltage should have been achieved by this time. If the bulk time limit is satisfied the charger will move directly to float stage.

ii. Re-bulk method

The re-bulk method setting allows selection between constant current or battery voltage method to trigger the charger back into bulk charge stage. When the charger is configured in a VE.Smart network with multiple chargers this setting is overridden and battery voltage is used.

iii. Re-bulk voltage offset

The re-bulk voltage offset setting is used to determine the re-bulk voltage threshold that will trigger a new charge cycle; the offset is relative to the configured Storage voltage (re-bulk voltage = storage voltage - re-bulk voltage offset). If the battery voltage falls below re-bulk voltage threshold while the charger is in float or storage stage and remains below it for one minute, the charger will move back into bulk charge stage.

iv. Re-bulk current

The re-bulk current setting is the charge current limit that will trigger a new charge cycle. If the charge current exceeds the re-bulk current threshold for four seconds while the charger is in float or storage stage, the charger to move back into bulk charge stage.

Note that even when the re-bulk setting is disabled, re-bulk will still occur if the charge current is maintained at the maximum charge current for four seconds while the charger is in float or storage stage.

C. Absorption

i. Absorption duration

The absorption duration setting allows selection between adaptive absorption time (calculated based on the bulk time / level of discharge) or a fixed absorption time.

ii. **Maximum absorption time / Absorption time**

The maximum absorption time / absorption time setting enables the maximum adaptive absorption time or the fixed absorption time to be configured (depending if adaptive or fixed absorption time is selected). Note that regardless if adaptive or fixed absorption time is selected, the absorption phase can end early based on the tail current setting (if enabled).

iii. **Tail current**

The tail current setting enables the absorption stage to be ended early based on charge current. If the charge current drops below the tail current threshold for one minute, the absorption stage will immediately end and the charger will move to float or storage stage.

iv. **Repeated absorption**

The repeated absorption setting enables the elapsed time between each automatic refresh charge cycle (1h in absorption stage) to be configured. Repeated absorption is enabled by default and can be disabled which results in the battery staying in storage mode indefinitely.

D. **Recondition**

i. **Recondition current percentage**

The recondition current percentage is used to establish the charge current limit while the charger is in recondition stage; the percentage is relative to the configured Maximum charge current. The charger will limit charge current to this lower level while in recondition stage.

ii. **Recondition stop mode**

The recondition stop mode setting allows selection between the recondition stage being ended upon the battery voltage reaching the recondition stage voltage setpoint or a fixed time period.

iii. **Maximum recondition duration**

The recondition time setting enables the maximum recondition time or the fixed recondition time to be configured (depending on the recondition stop mode selected).

iv. **Manual recondition**

Manual recondition can be started by selecting on the **START NOW** button. The duration of the recondition cycle is limited to a maximum of 1 hour.

8.3. VE.Smart Networking

The **Blue Smart IP22 Charger** range feature **VE.Smart networking** capability, which enables Bluetooth communication between compatible Victron products to optimise charger operation and battery performance/life; refer to the 'Operation > VE.Smart Networking' section for more information.

VE.Smart networking needs to be enabled and configured using a Bluetooth enabled device (mobile phone or tablet) with the **VictronConnect** app.

8.3.1. Voltage, temperature and current sense

To setup a **VE.Smart Network** with **Volt-Sense / Temp-Sense / Current-Sense**:

- Using a Bluetooth enabled device (mobile phone or tablet), open the **VictronConnect** app and locate the **battery monitor** (BMV, SmartShunt, Smart Battery Sense or VE.Bus Smart Dongle) in the Device list Local page, then connect to the device (the default PIN code is stated on a label located on the battery monitor, or try 000000 if there is no label).

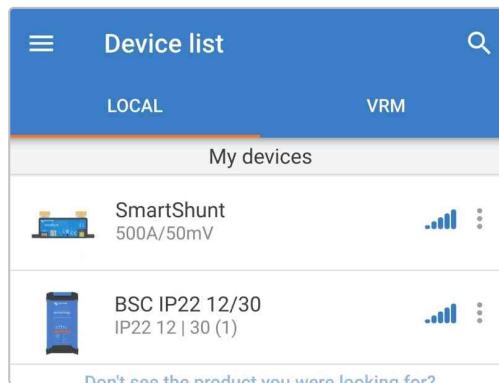

- Select the **Settings** icon (gear in the top right corner) to access the Settings page.



- Select **VE.Smart networking** to access the VE.Smart networking page.

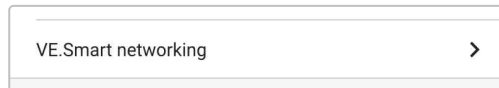

- Select **CREATE NETWORK** (or **JOIN NETWORK** if a VE.Smart network has already been created).

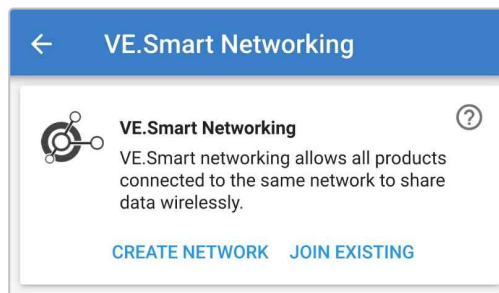

- Enter a name to identify the VE.Smart network and then select **OK**.

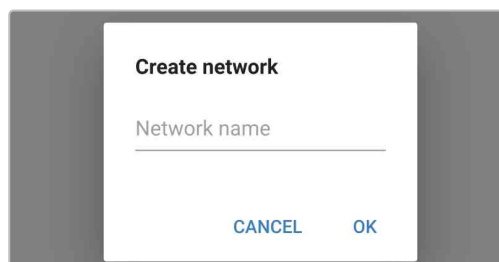

- After a short delay a pop-up dialog box will appear confirming that the network has been successfully configured; select **OK** to close the dialog box.

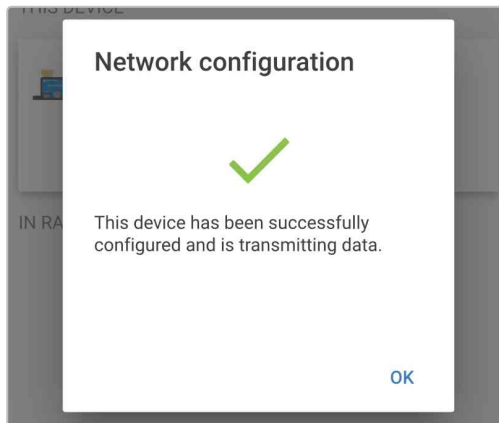

- The VE.Smart network configuration details are displayed within the the VE.Smart networking page.

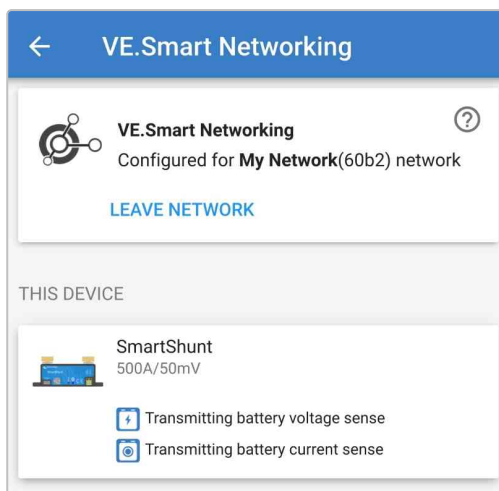

- End the current Bluetooth session by exiting into the **VictronConnect** Device list Local page.
- Connect the **Blue Smart IP22 Charger** AC power cable to a mains power outlet; after a short delay the LEDs indicating the current charge mode and charge state will illuminate.

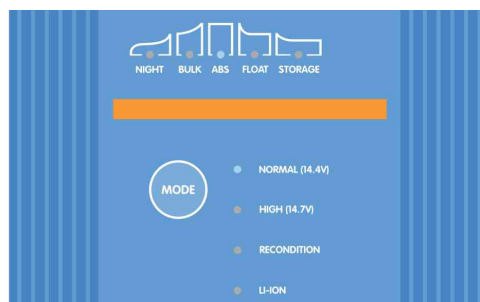

- Using a Bluetooth enabled device (mobile phone or tablet), open the **VictronConnect** app and locate the **Blue Smart IP22 Charger** (or other VE.Smart networking compatible charger) in the Device list Local page, then connect to the device (the default PIN code is stated on a label located on the back of the charger, or try 000000 if there is no label).

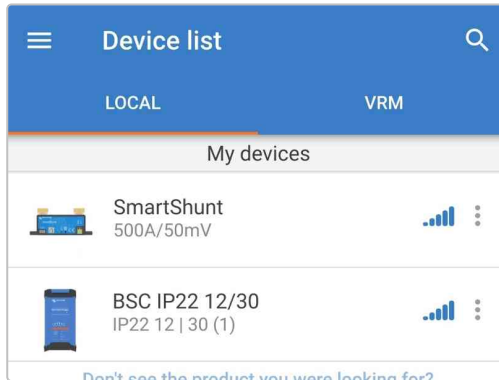

- Select the **Settings** icon (gear in the top right corner) to access the Settings page.



- Select **VE.Smart networking** to access the VE.Smart networking page.

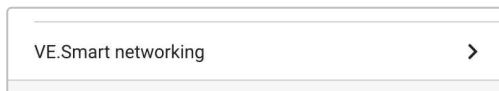

- Select **JOIN EXISTING**.



- Select the existing VE.Smart network you want to join, then select **OK**.

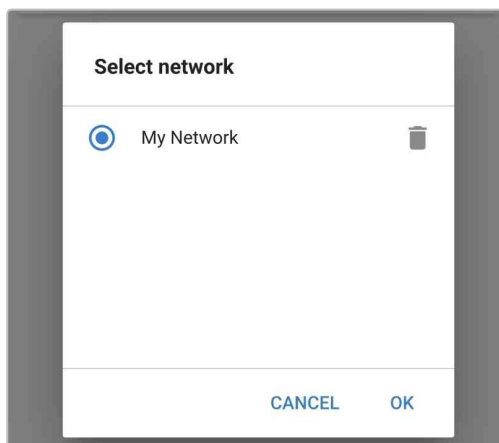

15. After a short delay a pop-up dialog box will appear confirming that the network has been successfully configured; select **OK** to close the dialog box.

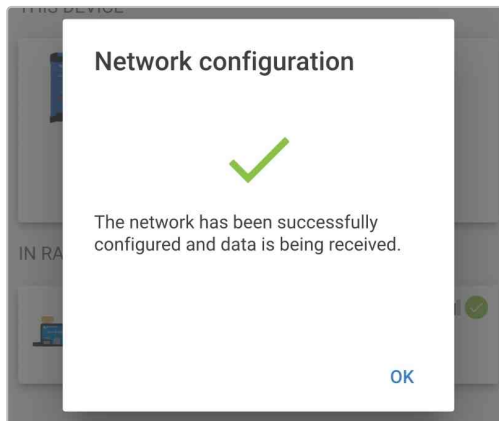

16. The VE.Smart network configuration details are displayed within the the VE.Smart networking page.

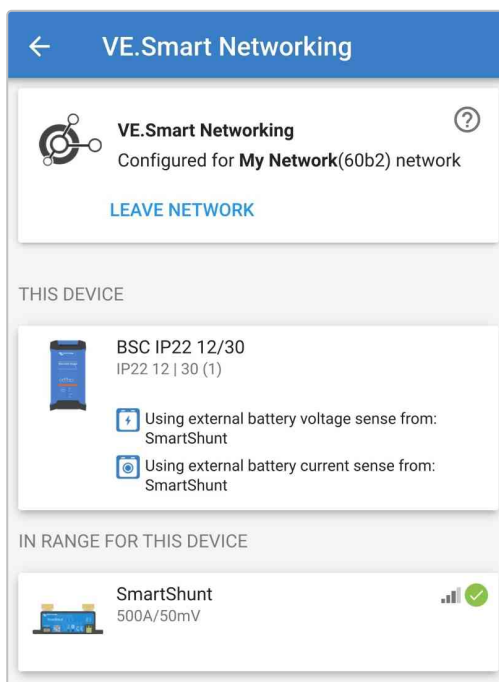

17. For systems with additional VE.Smart networking compatible chargers connected to the same battery / battery bank, repeat steps 8 to 16 above to include each remaining charger into the common VE.Smart network.

18. VE.Smart networking has now been configured; when VE.Smart networking is enabled:

- A. The VE.Smart network symbol will appear in the top right corner of the Status screen (of all devices within the VE.Smart network).

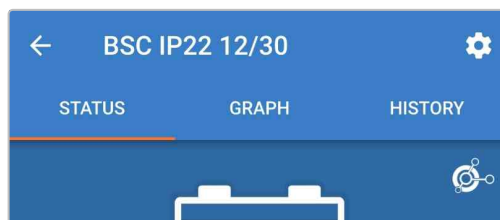

- B. The active charge state LED on the charger (BULK, ABS, FLOAT and STORAGE) will blink (turn off) momentarily every 4 seconds.





Multiple chargers in a common VE.Smart network must all have the same charge settings, since the master can change dynamically.

8.3.2. Synchronised charging

To setup a VE.Smart Network with Synchronised charging:

1. Connect all **Blue Smart IP22 Charger** AC power cables to a mains power outlet; after a short delay the LEDs indicating the current charge mode and charge state will illuminate.

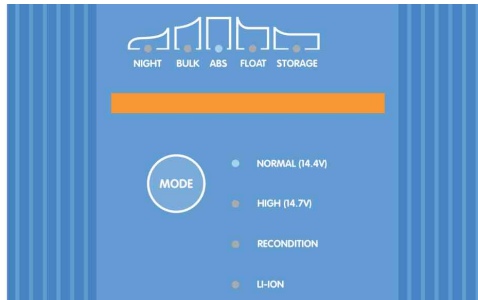

2. Using a Bluetooth enabled device (mobile phone or tablet), open the **VictronConnect** app and locate the first **Blue Smart IP22 Charger** in the Device list Local page, then connect to the device the default PIN code is stated on a label located on the back of the charger, or try 000000 if there is no label).

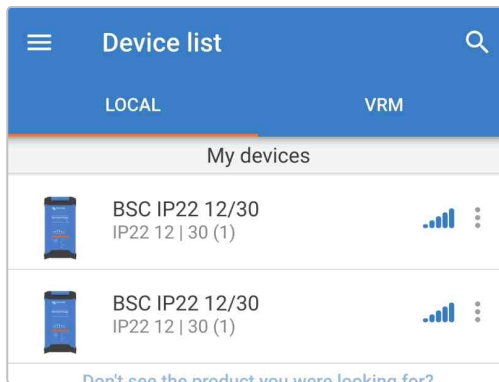

3. Select the **Settings** icon (gear in the top right corner) to access the Settings page.



4. Select **VE.Smart networking** to access the VE.Smart networking page.

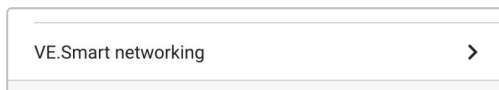

5. Select **CREATE NETWORK** (or **JOIN NETWORK** if a VE.Smart network has already been created).

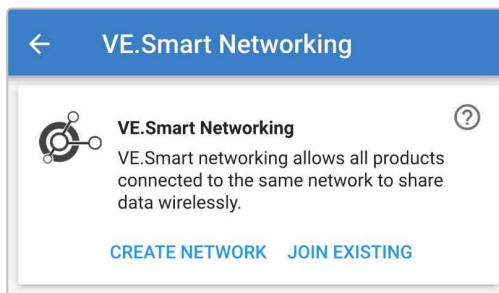

- 6. Enter a name to identify the VE.Smart network and select **OK**.

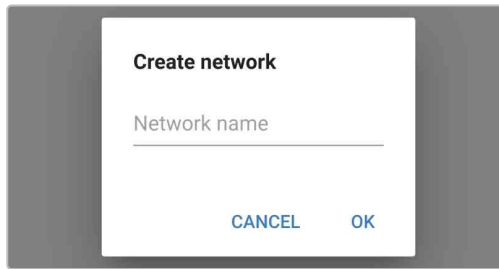

- 7. After a short delay a pop-up dialog box will appear confirming that the network has been successfully configured; select **OK** to close the dialog box.

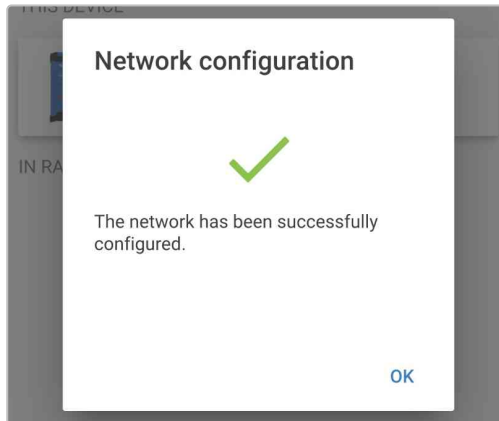

- 8. The VE.Smart network configuration details are displayed within the the VE.Smart networking page.

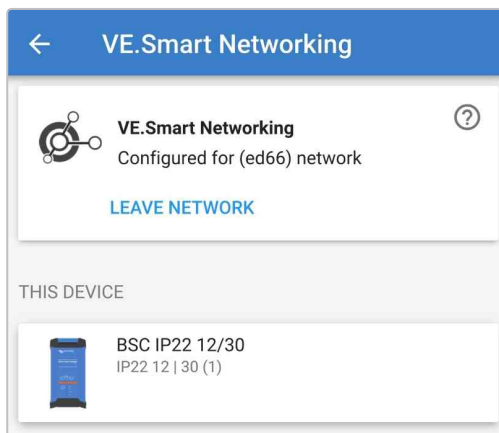

- 9. End the current Bluetooth session by exiting into the **VictronConnect** Device list Local page.
- 10. Using a Bluetooth enabled device (mobile phone or tablet), open the **VictronConnect** app and locate the subsequent **Blue Smart IP22 Charger** (or other VE.Smart networking compatible charger) in the Device list Local page, then connect to the device (the default PIN code is stated on a label located on the back of the charger, or try 000000 if there is no label).

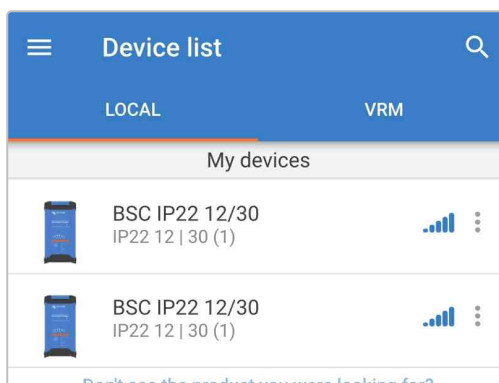

11. Select the **Settings** icon (gear in the top right corner) to access the Settings page.



12. Select **VE.Smart networking** to access the VE.Smart networking page.

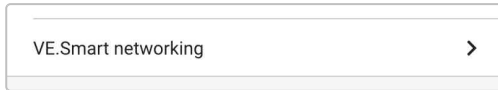

13. Select **JOIN EXISTING**.

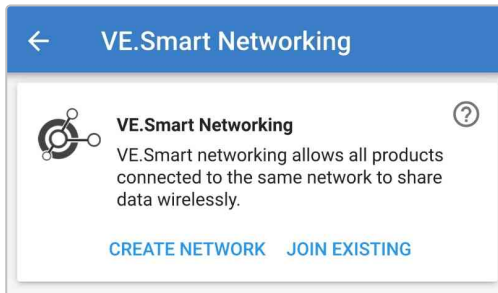

14. Select the existing VE.Smart network you want to join, then select **OK**.

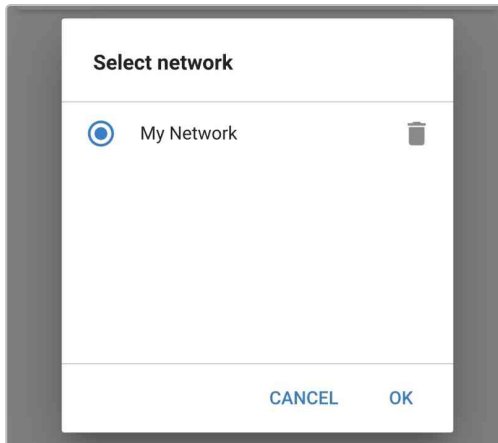

15. After a short delay a pop-up dialog box will appear confirming that the network has been successfully configured; select **OK** to close the dialog box.

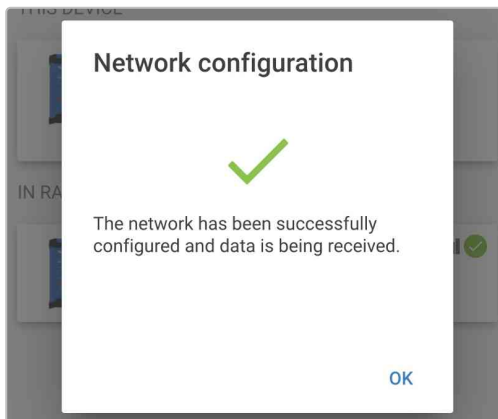

16. The VE.Smart network configuration details are displayed within the the VE.Smart networking page.

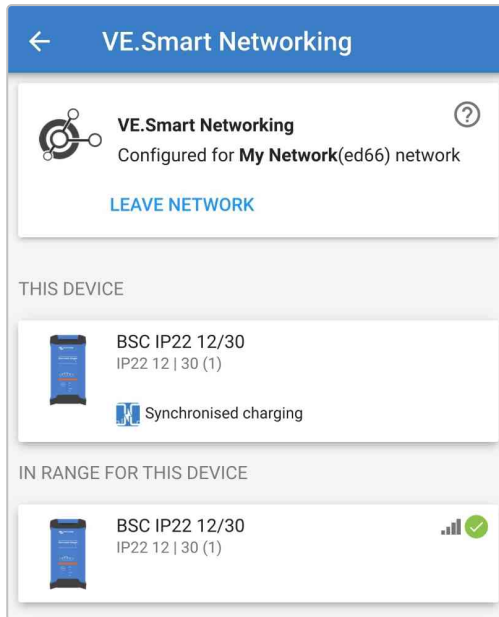

17. For systems with additional VE.Smart networking compatible chargers connected to the same battery / battery bank, repeat steps 9 to 17 to include each remaining charger into the common VE.Smart network.

18. VE.Smart networking has now been configured; when VE.Smart networking is enabled:

- A. The VE.Smart network symbol will appear in the top right corner of the STATUS screen (of all devices within the VE.Smart network).

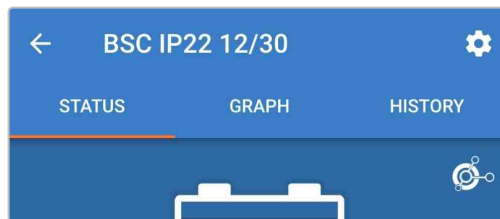

- B. The active charge state LED on the charger (BULK, ABS, FLOAT and STORAGE) will blink (turn off) momentarily every 4 seconds.



i Multiple chargers in a common VE.Smart network must all have the same charge settings, since the master can change dynamically.

8.4. Power supply mode

The **Blue Smart IP22 Charger** range is also suitable for use as a DC power supply, to directly power loads with or without a battery connected.

When the charger is used specifically as a DC power supply it is recommended to activate Power supply mode, which will disable the internal charge logic and provide a constant (configurable) DC voltage to the loads.

To enable power supply mode:

1. Connect the **Blue Smart IP22 Charger** AC power cable to a mains power outlet; after a short delay the LEDs indicating the current charge mode and charge state will illuminate.

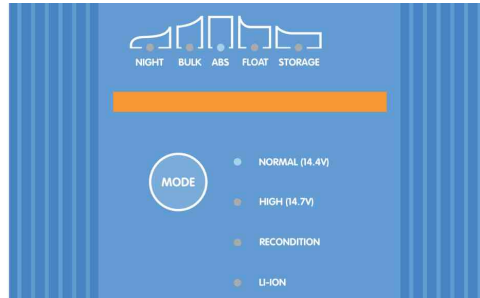

2. Using a Bluetooth enabled device (mobile phone or tablet), open the **VictronConnect** app and locate the **Blue Smart IP22 Charger** in the Device list Local page, then connect to the device (the default PIN code is stated on a label located on the back of the charger, or try 000000 if there is no label).
3. Select the **Settings** icon (gear in the top right corner) to access the Settings page.



4. Select the **Charger** in the Function field to open the Function pop-up dialog box.

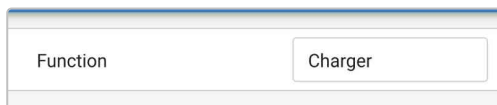

5. Select **Power supply** from the Function pop-up dialog box, then select **OK**.

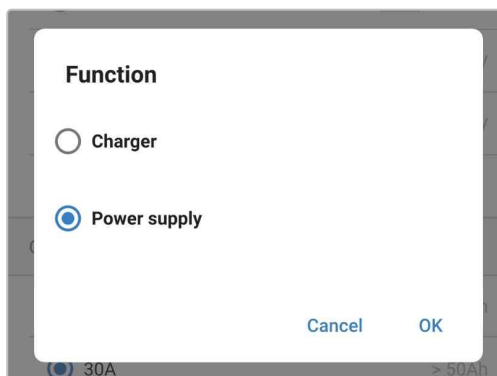

6. After a short delay the BULK, ABS, FLOAT and STORAGE LEDs will be illuminated to indicate the charger function has changed to Power supply mode.

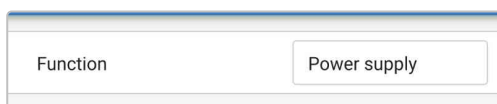

7. If required, adjust the desired output voltage and/or the maximum current limit.

Function	Power supply
Night mode Reduce output current for fan-less operation for the next 8 hours	
Output voltage	12.80V
Maximum current	30.0A

8. Power supply mode has now been enabled and configured.

To revert the charger function back to use as a normal battery charger, follow steps 1 to 4 above and then select **Charger** from the Function pop-up dialog box.

9. Technical specifications

Electrical		12/15	12/20	12/30	24/8	24/12	24/16
Mains power voltage (Nominal Min/Max)		220 - 240VAC 180 - 265VAC					
Mains power frequency (Nominal Min/Max)		50 - 60Hz 45 - 65Hz					
Power factor		>0.6					
Standby power		0.5W					
Max efficiency		93%			94%		
Charge voltage (Absorption Float Storage)	Normal	14.4V 13.8V 13.2V			28.8V 27.6V 26.4V		
	High	14.7V 13.8V 13.2V			29.4V 27.6V 26.4V		
	Li-ion	14.2V N/A 13.5V			28.4V N/A 27.0V		
Temperature compensation (N/A for Li-ion)		-16mV/°C (-9mV/°F)			-32mV/°C (-18mV/°F)		
Charge algorithm		6-stage adaptive (3 stage for Li-ion)					
Charge current limit (in selected mode)	Max	15A	20A	30A	8A	12A	16A
	Low	7.5A	10A	15A	4A	6A	8A
	Min	3.7A	5A	7.5A	2A	3A	4A
Max battery capacity (≥0.1C in max mode)		150Ah	200Ah	300Ah	80Ah	120Ah	160Ah
Min battery capacity - Lead-acid (≤0.3C in selected mode)	Max	50Ah	67Ah	100Ah	27Ah	40Ah	53Ah
	Low	25Ah	33Ah	50Ah	13Ah	20Ah	27Ah
	Min	12Ah	17Ah	25Ah	7Ah	10Ah	13Ah
Min battery capacity - Li-ion (≤0.5C in selected mode)	Max	30Ah	40Ah	60Ah	16Ah	24Ah	32Ah
	Low	15Ah	20Ah	30Ah	8Ah	12Ah	16Ah
	Min	7Ah	10Ah	15Ah	4Ah	6Ah	8Ah
Fault protection		Reverse polarity (fuse), output short circuit and over temperature					
Communication		Bluetooth (via VictronConnect app)					
Bluetooth power and frequency		+4dBm 2402 - 2480MHz					
Cooling		Fan assisted (except 12/15 and 24/08)					
Operating temperature range		-20 to 50°C (-4 to 122°F) with full rated output up to 40°C (104°F)					
Max humidity		95%					
Physical							
Material and colour		Aluminium Blue RAL 5012					
Mains power connection		1.5m (5ft) mains cable with CEE 7/7, BS 1363 or AS/NZS 3112 plug					
Battery connection	Type	16mm ² (6 AWG) screw terminals					
	Outputs	1 output or 3 isolated outputs (except 24/8 and 24/12 models)					
Output fuse rating		20A	30A	40A	15A	20A	25A
Ingress protection (IP) rating		IP22					
Weight		1.3kg (2.9lbs)					
Dimensions (h x w x d)		235 x 108 x 65 mm (9.3 x 4.3 x 2.6 inch)					
Compliance							
Safety		EN 60335-1, EN 60335-2-29					
EMC		ETSI EN 301 489-1 V2.2.3, ETSI EN 301 489-17 V3.2.4, ETSI EN 300 328 V2.2.2					
Automotive		ECE R10					

10. Warranty

This limited warranty covers defects in materials and workmanship in this product, and lasts for five years from the date of original purchase of this product.

The customer must return the product together with the receipt of purchase to the point of purchase.

This limited warranty does not cover damage, deterioration or malfunction resulting from alteration, modification, improper or unreasonable use or misuse, neglect, exposure to excess moisture, fire, improper packing, lightning, power surges, or other acts of nature.

This limited warranty does not cover damage, deterioration or malfunction resulting from repairs attempted by anyone unauthorized by Victron Energy to make such repairs.

Victron Energy is not liable for any consequential damages arising from the use of this product.

The maximum liability of Victron Energy under this limited warranty shall not exceed the actual purchase price of the product.