

## Lynx Shunt VE.Can (M8)

# Table of Contents

<b>1. Safety Precautions</b> .....	<b>1</b>
1.1. Safety Warnings Lynx Distribution System .....	1
1.2. Transport and Storage .....	1
<b>2. Introduction</b> .....	<b>2</b>
2.1. The Lynx Shunt VE.Can .....	2
2.2. What's in the box? .....	2
2.3. GX device .....	3
2.4. Temperature sensor .....	3
2.5. The Lynx Distribution System .....	4
<b>3. Features</b> .....	<b>5</b>
3.1. Internal parts and wiring diagram Lynx Shunt VE.Can .....	5
3.2. Main fuse .....	5
3.3. Battery Monitor (shunt) .....	5
3.4. Alarm relay .....	6
3.5. Temperature sensor .....	6
<b>4. Communication and interfacing</b> .....	<b>7</b>
4.1. GX Device .....	7
4.2. NMEA 2000 .....	7
<b>5. System Design</b> .....	<b>8</b>
5.1. Lynx distribution system parts .....	8
5.1.1. Interconnecting Lynx modules .....	8
5.1.2. Orientation of Lynx modules .....	9
5.1.3. System example - Lynx Shunt VE.Can, Lynx Power In, Lynx Distributor and lead acid batteries .....	10
5.2. System sizing .....	10
5.2.1. Current rating Lynx modules .....	10
5.2.2. Fusing .....	11
5.2.3. Cabling .....	11
<b>6. Installation</b> .....	<b>12</b>
6.1. Mechanical connections .....	12
6.1.1. Lynx module connection features .....	12
6.1.2. Mounting and interconnecting Lynx modules .....	12
6.2. Electrical connections .....	13
6.2.1. Connect DC wires .....	13
6.2.2. Connect RJ10 cable(s) .....	13
6.2.3. Connect the temperature sensor .....	14
6.2.4. Connect the alarm relay .....	14
6.2.5. Place main fuse .....	14
6.2.6. Connect the GX device .....	15
6.3. Configuration and settings .....	16
6.3.1. Settings Lynx Shunt VE.Can .....	16
<b>7. Commissioning the Lynx Shunt VE.Can</b> .....	<b>17</b>
<b>8. Operation Lynx Shunt VE.Can</b> .....	<b>18</b>
<b>9. Battery monitor settings</b> .....	<b>20</b>
9.1. Battery capacity .....	20
9.2. Charged voltage .....	20
9.3. Tail current .....	20
9.4. Charged detection time .....	21
9.5. Peukert exponent .....	21
9.6. Charge efficiency factor .....	21
9.7. Current threshold .....	21
9.8. Time-to-go averaging period .....	21

9.9. Synchronise SoC to 100% .....	21
9.10. Zero current calibration .....	22
<b>10. Battery capacity and Peukert exponent .....</b>	<b>23</b>
<b>11. Troubleshooting and Support .....</b>	<b>25</b>
11.1. Cabling issues .....	25
11.2. Main fuse issues .....	25
11.3. Battery monitor issues .....	25
11.3.1. Charge and discharge current are inverted .....	25
11.3.2. Incomplete current reading .....	25
11.3.3. There is a current reading while no current flows .....	25
11.3.4. Incorrect state of charge reading .....	26
11.3.5. State of charge always shows 100% .....	26
11.3.6. State of charge does not reach 100% .....	26
11.3.7. State of charge does not increase fast enough or too fast when charging .....	26
11.3.8. State of charge is missing .....	27
11.3.9. Synchronisation issues .....	27
11.4. GX device issues .....	27
<b>12. Technical specifications Lynx Shunt VE.Can (M8) .....</b>	<b>28</b>
<b>13. Enclosure dimensions Lynx Shunt VE.Can .....</b>	<b>29</b>

# 1. Safety Precautions

## 1.1. Safety Warnings Lynx Distribution System



- Do not work on live busbars. Ensure that the busbar is unpowered by disconnecting all positive battery poles prior to removing the Lynx front cover.
- Work on batteries should be carried out by qualified personnel only. Observe the battery safety warnings as listed in the battery manual.

## 1.2. Transport and Storage

Store this product in a dry environment.

The storage temperature should be: -40°C to +65°C.

No liability can be accepted for damage in transit if the equipment is not transported in its original packaging.

## 2. Introduction

### 2.1. The Lynx Shunt VE.Can

The Lynx Shunt VE.Can (M8) is an integral part of the Lynx Distribution system, featuring a positive and negative busbar, a battery monitor, and a fuse holder for the main system fuse. It is available in two versions: M8 and M10. The shunt can communicate with GX devices via VE.Can. Additionally, it is equipped with a power LED for status indication.

*The Lynx Shunt VE.Can(M10) - with and without cover*

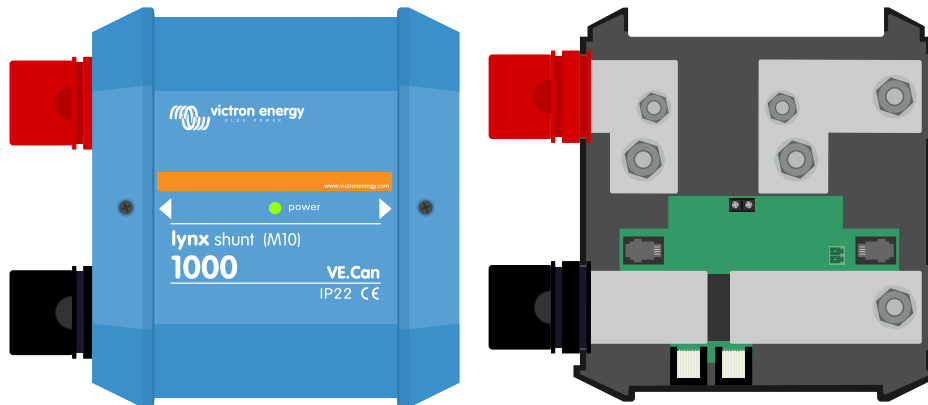

*The Lynx Shunt VE.Can (M8) - with and without cover*

Two VE.Can RJ45 terminators are included, which are used when connecting to a GX device.

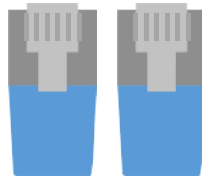



*Two VE.Can RJ45 VE terminators*

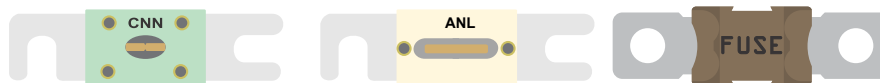

The Lynx Shunt VE.Can M8 is designed to hold a CNN fuse, while the M10 model can also accommodate an ANL or Mega fuse. The fuses need to be purchased separately. For more info see [Fusing \[11\]](#)



*Examples of a CNN, ANL and Mega fuse*

### 2.2. What's in the box?

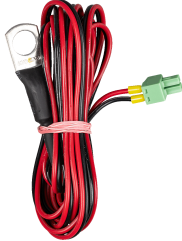
<p>Lynx Shunt VE.Can (M8)</p>	
<p>VE.Can RJ45 terminators (2 pcs)</p>	

<p>Temperature sensor (ASS000001000) with ferrules and terminal block</p>	
<p>Upside-down sticker with quick installation guide</p>	

## 2.3. GX device

The Lynx Shunt VE.Can (M8) can be monitored and set up with a GX device.

For more information on the GX device, see the [GX device product page](#).

The GX device can be connected to the VRM portal, allowing remote monitoring.

For more information on the VRM portal, see the [VRM page](#).

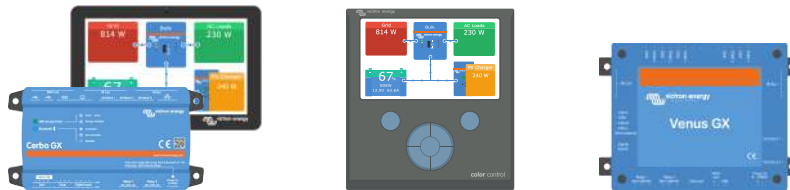

*GX devices: Cerbo GX & GX Touch, CCGX and Venus GX*

## 2.4. Temperature sensor

A temperature sensor can be connected to the Lynx Shunt VE.Can (M8). It is used to measure the battery temperature.

The temperature sensor is included with the Lynx Shunt VE.Can (M8). For more information see the [Temperature sensor QUA PMP GX device product page](#).

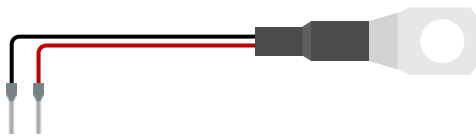

*The temperature sensor QUA PMP GX device*

## 2.5. The Lynx Distribution System

The Lynx Distribution System is a modular busbar system that incorporates DC connections, distribution, fusing, battery monitoring and/or Lithium battery management. For more information, see the [DC Distribution Systems product page](#).

The Lynx Distribution System consist of the following parts:

- **Lynx Power In** - A positive and negative busbar with four batteries or DC equipment connections, available in two versions, with M8 or M10 busbar.
- **Lynx Class-T Power In** - A positive and negative busbar that accepts two Class-T fuses and has two battery or DC equipment connections, available with M10 busbar.
- **Lynx Distributor** - A positive and negative busbar with four fused connections for batteries or DC equipment and fuse monitoring, available in two versions, with M8 or M10 busbar.
- **Lynx Shunt VE.Can** - A positive busbar with a space for a main system fuse and a negative busbar with a shunt for battery monitoring. It has VE.Can communication for monitoring and setup with a GX device. Available in two versions, with M8 or M10 busbar.
- **Lynx Smart BMS** - For use together with Victron Energy Smart Lithium batteries. It contains a positive busbar with a contactor driven by a battery management system (BMS) and a negative busbar with a shunt for battery monitoring. It has Bluetooth communication for monitoring and setup via the VictronConnect App and VE.Can communication for monitoring with a GX device and the VRM portal. Available as a 500A model with M8 or M10 busbars or 1000A model with M10 busbars.

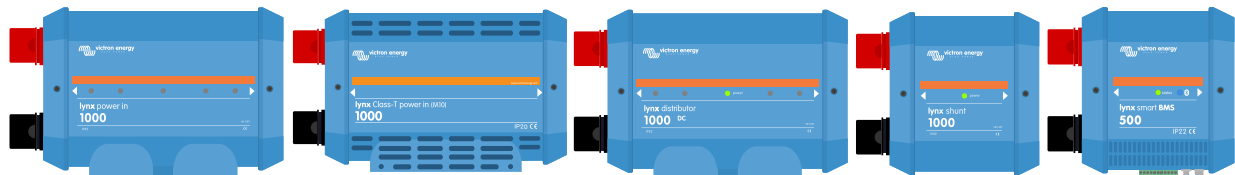

The Lynx modules: Lynx Power In, Lynx Class-T Power In, Lynx Distributor, Lynx Shunt VE.Can and Lynx Smart BMS

## 3. Features

### 3.1. Internal parts and wiring diagram Lynx Shunt VE.Can

The internal physical parts and the wiring diagram of the Lynx Shunt VE.Can indicating the following parts:

- Positive busbar
- Negative busbar
- Main system fuse
- Shunt

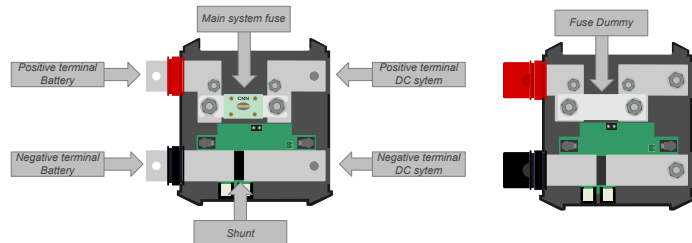

The internal physical parts of the Lynx Shunt VE.Can and on the right the M10 model with fuse dummy installed instead of the fuse

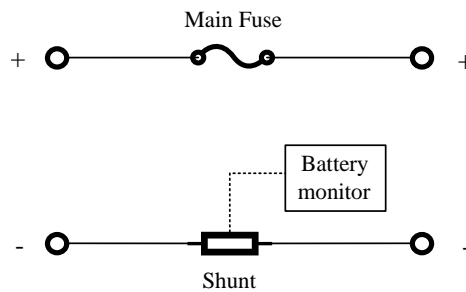

The internal wiring diagram of the Lynx Shunt VE.Can

### 3.2. Main fuse

The Lynx Shunt houses the system's main fuse.

The fuse is being monitored by the Lynx Shunt VE.Can. If the fuse blows, the power LED lights up red and an alarm message is sent to the GX device.

The built-in relay can be controlled by the blown fuse parameter from a GX device.

### 3.3. Battery Monitor (shunt)

The Lynx Shunt VE.Can (M8) battery monitor operates in a similar fashion as the other [Victron Energy battery monitors](#). It contains a shunt and battery monitor electronics.

Readout of the battery monitor data is via a GX device or the VRM portal.

### 3.4. Alarm relay

The Lynx Shunt VE.Can (M8) has an alarm relay. This relay can be programmed via the GX device to open or close using the following parameters:

- Battery State of charge
- Battery voltage
- Battery temperature
- Fuse blown

The alarm relay can, for example, be used to start or stop a generator based on the battery's state of charge or voltage. The alarm messages sent to the GX device or the VRM portal are programmable in a similar manner.

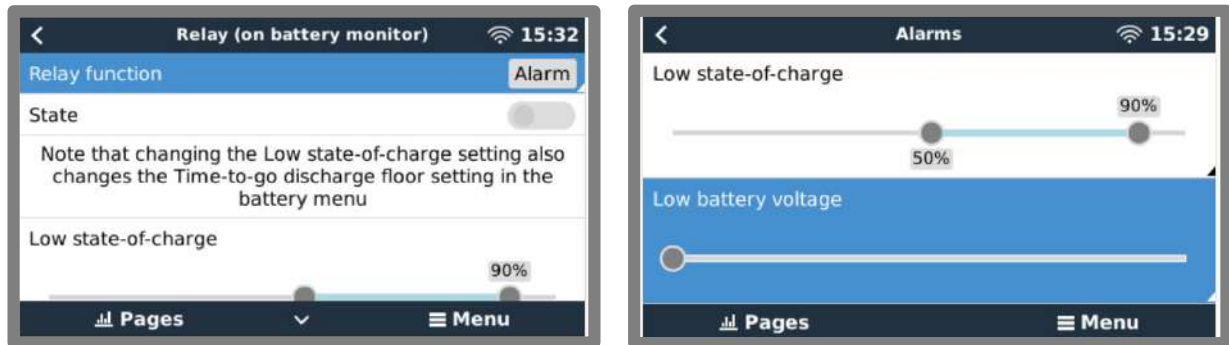

*GX device settings alarm relay and alarm messages*

### 3.5. Temperature sensor

The temperature sensor measures the battery temperature and can be used to drive the Lynx Shunt VE.Can alarm relay.

The temperature data or temperature alarms will also be sent to the GX device and from there to the VRM portal. On the VRM portal, the temperature data is logged and can be accessed.

**Figure 1. VRM data logging battery temperature example**

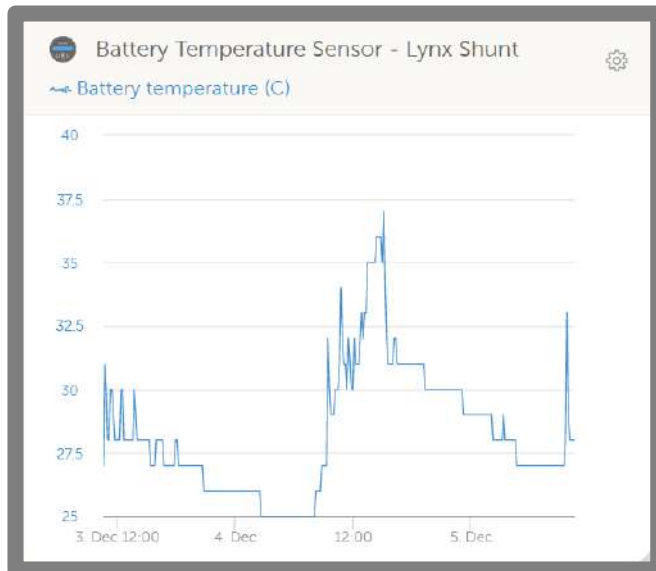

*Example of VRM battery temperature data logging*

## 4. Communication and interfacing

### 4.1. GX Device

The Lynx Shunt VE.Can (M8) can be connected to a GX device via VE.Can. The GX device will show all measured parameters, operational state, battery SoC and alarms.

Ensure that the VE.Can & Lynx Ion BMS (250 kbit/s) profile is selected on the GX device in Settings → Connectivity. This is the default profile for VE.Can communication. Note that the BMS-Can port cannot be used for this connection.

### 4.2. NMEA 2000

Communication with an NMEA 2000 network can be established via the Lynx Shunt VE.Can (M8) VE.Can connection together with a [VE.Can to NMEA2000 micro-C male cable](#).

Supported NMEA 2000 PGNs:

Product Information – PGN 126996

DC detailed Status – PGN 127506

DC/Battery Status – PGN 127508

Switch Bank Status - PGN 127501

- Status 1: Contactor
- Status 2: Alarm
- Status 3: Battery voltage low
- Status 4: Battery voltage high
- Status 5: Programmable relay status

Class and function:

N2K device class: Electrical generation

N2K device function: Battery

For more information see the [NMEA2000 & MFD integration guide](#).

## 5. System Design

### 5.1. Lynx distribution system parts

A Lynx distribution system consists of a single Lynx Shunt VE.Can module.

Then, single, multiple or a combination of Lynx Distributor modules and/or Lynx Power In/Lynx Class-T Power In modules are added.

Together they form a continuous negative and positive busbar with DC connections and, depending on the configuration, integrated fuses, a battery monitor and/or lithium battery management.

#### 5.1.1. Interconnecting Lynx modules

Each Lynx module can be connected to other Lynx modules on the left and right. Note that M10 modules cannot be connected directly to M8 modules and vice versa.

If the Lynx module is the first in line, the last in line or is used by itself, it is possible to connect batteries, loads or chargers directly to these connections. Please note that additional fusing may be required if batteries and loads are connected directly to the interconnections.

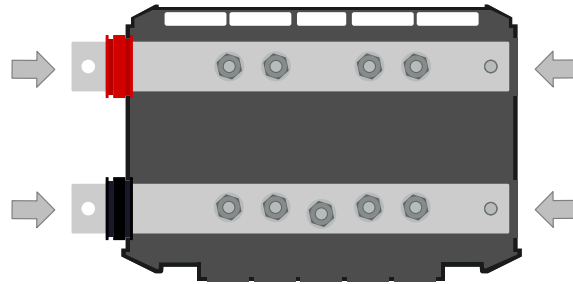

*Lynx connections: The arrows indicate where the other Lynx modules can connect*

The example below shows a Lynx system consisting of a Lynx Power In, Lynx Shunt VE.Can and Lynx Distributor. Together, they form a continuous busbar with unfused battery connections, battery monitor, main system fuse and fused load connections.

**Figure 2. Example of Interconnected Lynx modules without their covers (Lynx Shunt VE.Can)**

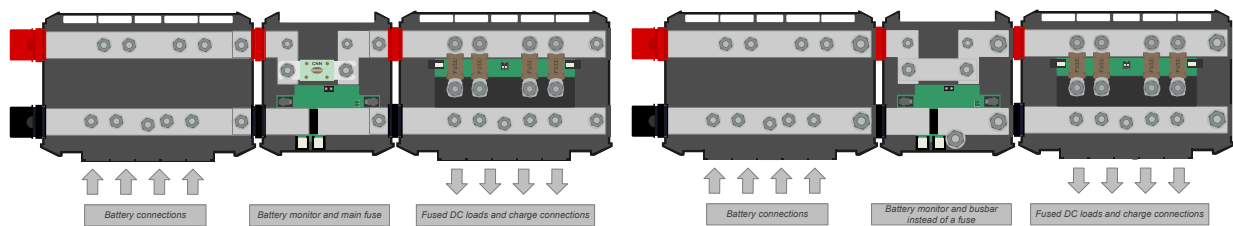

Interconnected Lynx modules: Lynx Power In, Lynx Shunt VE.Can and Lynx Distributor. On the right the M10 variant with busbar instead of the fuse

### 5.1.2. Orientation of Lynx modules

If the Lynx System contains a Lynx Shunt VE.Can, the batteries always have to be connected to the left side of the Lynx System and the rest of the DC system (loads and chargers) connect to the right side. This so the battery state of charge can be correctly calculated.

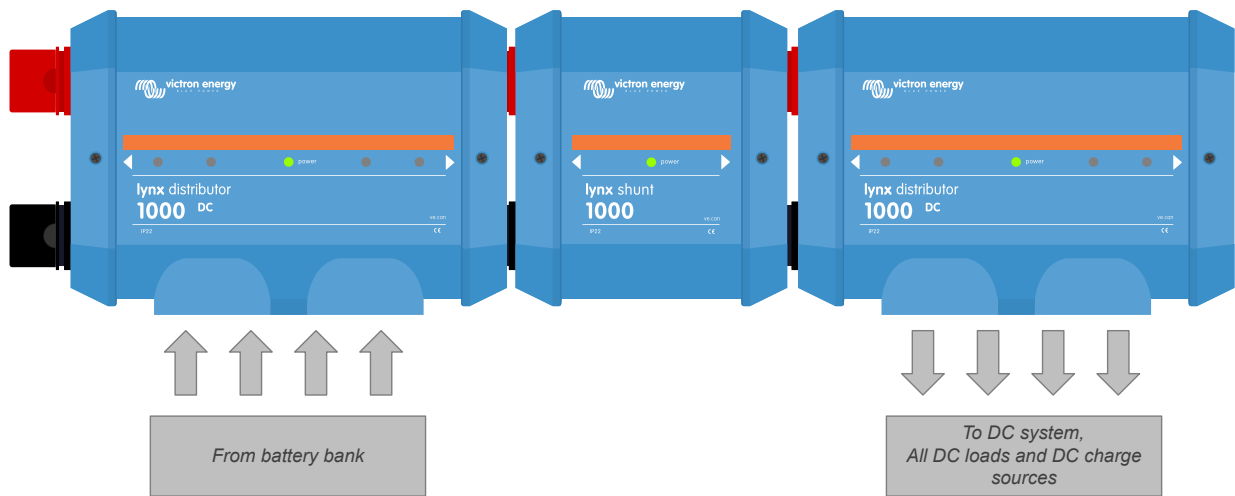

Example of Lynx module orientation: the batteries connect to the left side and all loads and chargers connect on the right side

The Lynx modules can be mounted in any orientation. Should they be mounted upside down so that the text on the front of the units is upside down as well, use the special stickers included with each Lynx module so that the text is orientated the correct way.

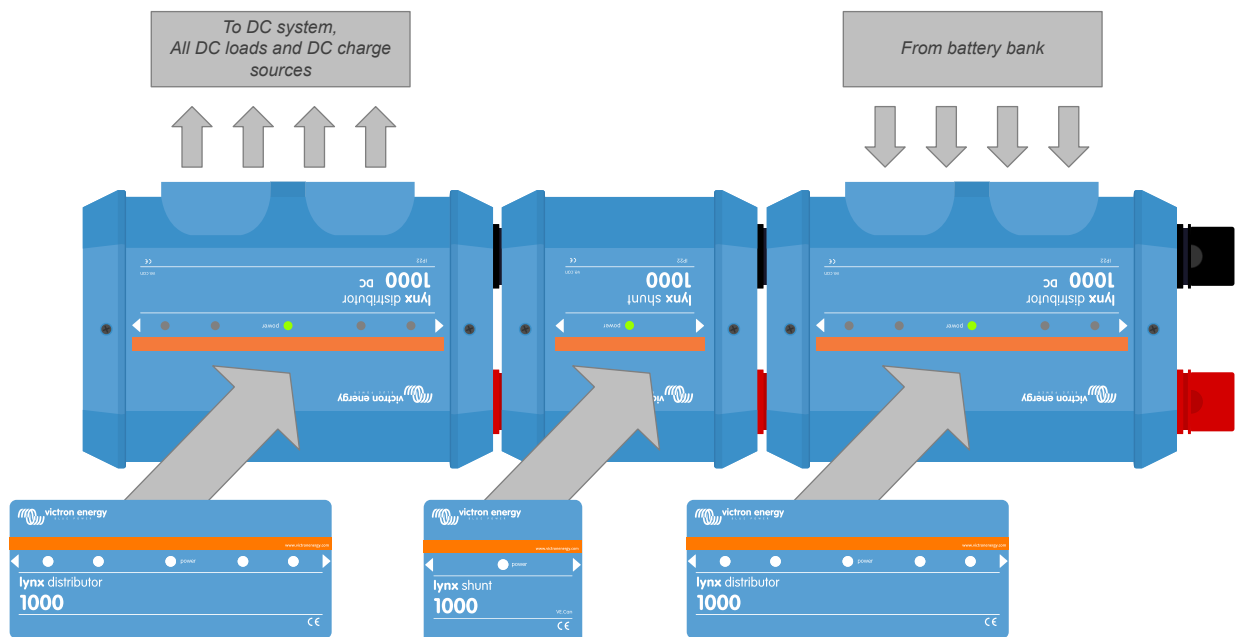

Example of Lynx modules mounted upside down: the batteries connect to the right side, all loads and chargers connect to the left side and the upside-down stickers are affixed.

### 5.1.3. System example - Lynx Shunt VE.Can, Lynx Power In, Lynx Distributor and lead acid batteries

This system contains the following components:

- Lynx Power In with 4 paralleled 12V lead acid batteries.
- Identical cable lengths for each battery.
- Lynx Shunt VE.Can with main system fuse and battery monitor.
- Lynx Distributor with fused connections for inverter/charger(s), loads and chargers. Note that additional modules can be added if more connections are needed.
- Cerbo GX (or other GX device) to read out the battery monitor data.

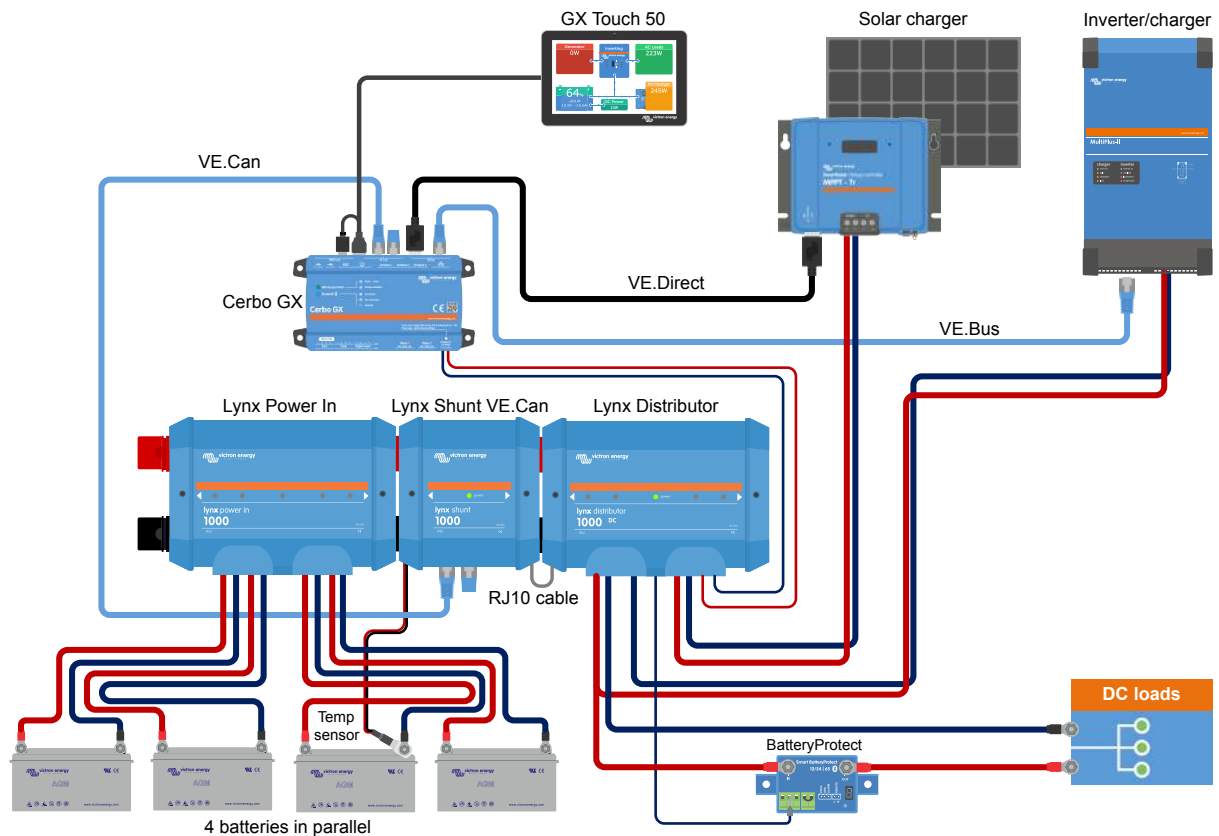

System with Lynx Shunt VE.Can, lead acid batteries and a Lynx Distributor

System with Lynx Shunt VE.Can, lead acid batteries and a Lynx Distributor

## 5.2. System sizing

### 5.2.1. Current rating Lynx modules

The Lynx Distributor, Lynx Shunt VE.Can, Lynx Class-T Power In and the Lynx Power In are rated for a nominal current of 1000A for 12, 24 or 48 System voltages.

See the table below for an idea of how much power the Lynx modules are rated at different voltages. The power rating will indicate how big the connected inverter/charger system can be. Remember that if inverters or inverter/chargers are used, the batteries will power both the AC and DC systems. Also, be aware that a Lynx Smart BMS or a Lynx Ion (now discontinued) can have a lower current rating.

	12V	24V	48V
1000A	12kW	24kW	48kW

### 5.2.2. Fusing

The Lynx Shunt VE.Can M8 model has a space for a CNN main fuse. It is also possible to install a Mega fuse on the M6 bolts. At Victron we stock the 325 A/ 80 V CNN fuse (part number CIP140325000), but they are available in 35 A up to 800 A from almost everywhere.

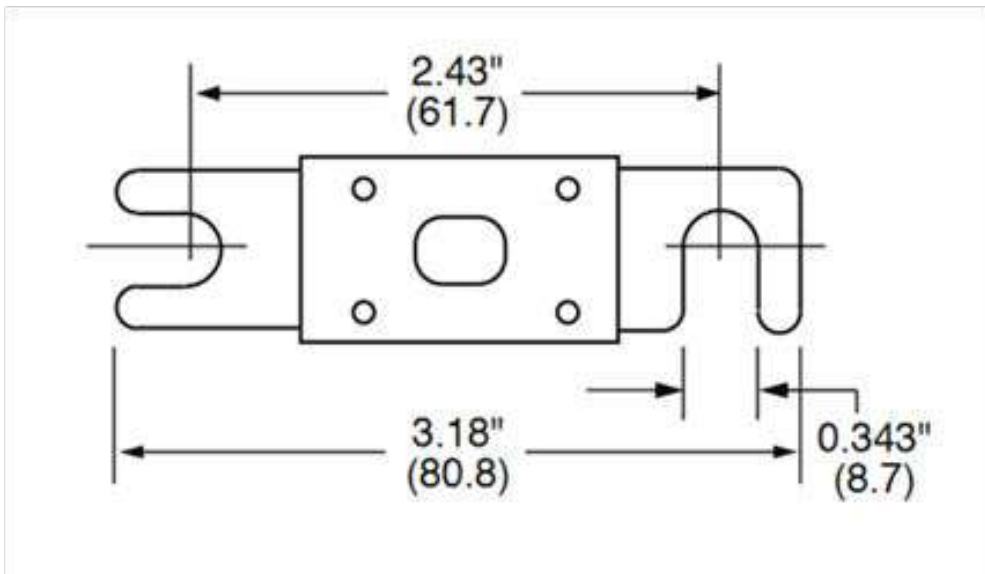

*CNN fuse dimensions in inches (mm)*

Always use fuses with the correct voltage and current rating. Match the fuse rating to the maximum voltages and currents that potentially can occur in the fused circuit. For more information on fuse ratings and fuse current calculations see the [Wiring Unlimited](#) book.



The total value of the fuses of all circuits should not be more than the current rating of the Lynx module or the Lynx model with the lowest current rating in case of multiple Lynx modules are used.

### 5.2.3. Cabling

The current rating of the wires or cables used to connect the Lynx Shunt VE.Can (M8) to batteries and/or the DC loads, has to be rated for the maximum currents that can occur in the connected circuits. Use cabling with a sufficient core surface area to match the maximum current rating of the circuit.

For more information on cabling and cable thickness calculations, see our book, [Wiring Unlimited](#).

## 6. Installation

### 6.1. Mechanical connections

#### 6.1.1. Lynx module connection features

The Lynx module can be opened up by unscrewing the 2 cover screws.

The contacts on the left side are covered by a removable rubber sleeve.

Red is the positive and black is the negative busbar.

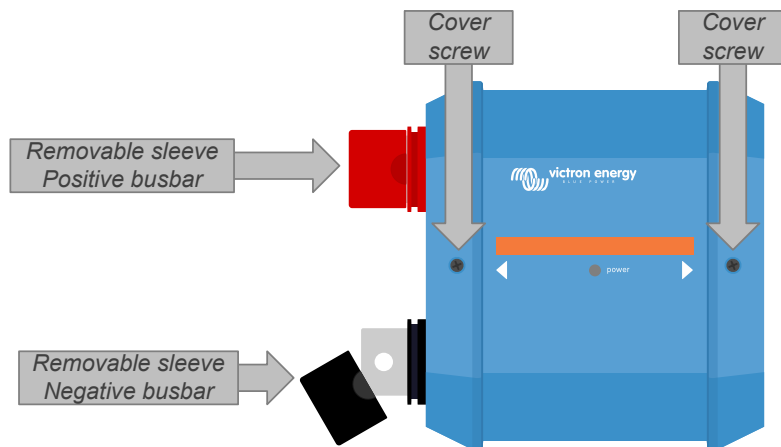

Location of front cover screws and the removable sleeves

#### 6.1.2. Mounting and interconnecting Lynx modules

This paragraph explains how to attach several Lynx modules to each other and how to mount the Lynx assembly into its final location.

For a mechanical drawing of the housing with dimensions and the location of the mounting holes, see the [Enclosure Dimensions](#) of this manual.

These are the points to take into consideration when interconnecting and mounting Lynx modules:

- If Lynx modules are going to be connected to the right and if the Lynx module is fitted with a plastic barrier on the right side, remove the black plastic barrier. If the Lynx module is located as the most right module, leave the black plastic barrier in place.
- If Lynx modules are going to be connected to the left, remove the red and black rubber sleeves. If the Lynx module is located as the most left module, leave the red and black rubber sleeves in place.
- If the Lynx system contains a Lynx Smart BMS or Lynx Shunt VE.Can, the left side is the battery and the right side is the DC system side.
- Connect all Lynx modules to each other using the M8 (M10) holes and bolts on the left and right. Take care that the modules are correctly slotted into the rubber joiner recesses.
- Place the washer, spring washer and nut on the bolts and tighten the bolts using a torque of:
  - M8 Model: 14Nm**
  - M10 Model: 33Nm**
- Mount the Lynx assembly in its final location using the 5mm mounting holes.

**Figure 3. Connection sequence when connecting two Lynx modules**

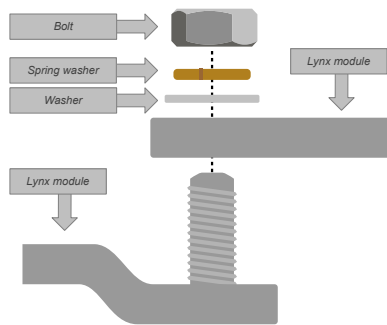

Correct placement of the M8 (M10) washer, spring washer and nut.

## 6.2. Electrical connections

### 6.2.1. Connect DC wires

This chapter might not apply if the Lynx module is connected to other Lynx modules like this can be the case for the Lynx Smart BMS or the Lynx Shunt VE.Can.

For all DC connections, the following applies:

- All cables and wires connected to the Lynx module need to have been fitted with M8 cable lugs.
- Pay attention to the correct placement of the cable lug, washer, spring washer and nut on each bolt when attaching the cable to the bolt.
- Tighten the nuts using a torque of:

**M8 Model: 14Nm**

**Figure 4. Correct mounting sequence DC wires**

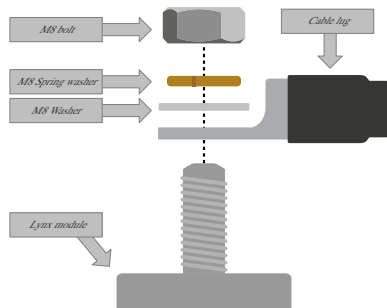

Correct placement of the M8 Cable lug, washer, spring washer and nut

### 6.2.2. Connect RJ10 cable(s)

These instructions only apply if the system contains Lynx distributor(s) together with a Lynx Smart BMS or a Lynx Shunt VE.Can.

There are two RJ10 connectors in each Lynx Distributor, one on the left and one on the right. See the drawing below.

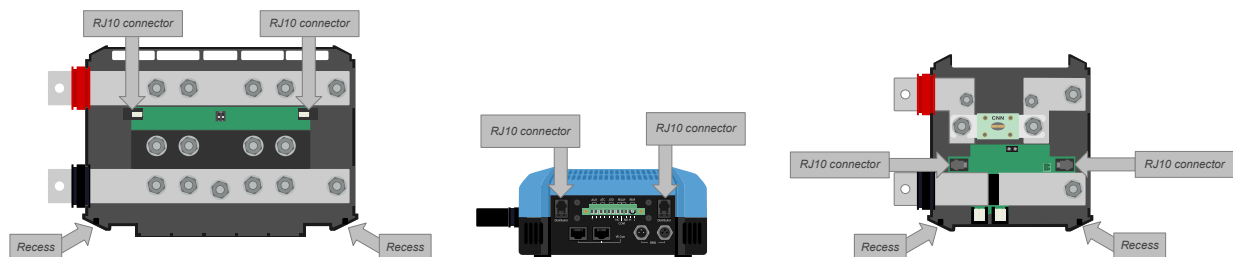

Locations of the RJ10 connectors and RJ10 cable recesses on the Lynx Distributor and the Lynx Shunt VE.Can

To connect the RJ10 cables between the various Lynx modules, do the following:

- Plug one side of the RJ10 cable in the RJ10 connector of the Lynx Distributor with the retainer clip of the RJ10 connector facing away from you.
- Feed the RJ10 cable through the recess at the bottom of the Lynx Distributor; see the above picture.
- To connect to a Lynx Shunt VE.Can, feed the cable through its bottom recess and plug the RJ10 cable into the RJ10 connector.

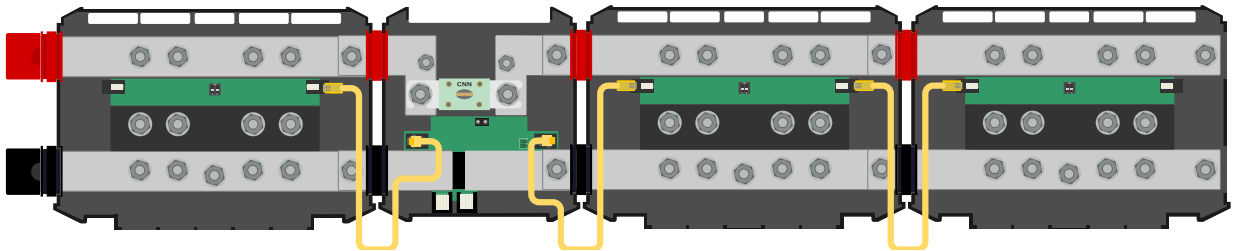

Connection example Lynx Shunt VE.Can system - RJ10 cables indicated in yellow

### 6.2.3. Connect the temperature sensor

The supplied battery temperature sensor can be connected to the green terminal with the + and - symbol.

The connector can be removed from the terminal, for easy connection.

The temperature sensor is polarity-sensitive. Connect the black wire to the - terminal and the red wire to the + terminal.

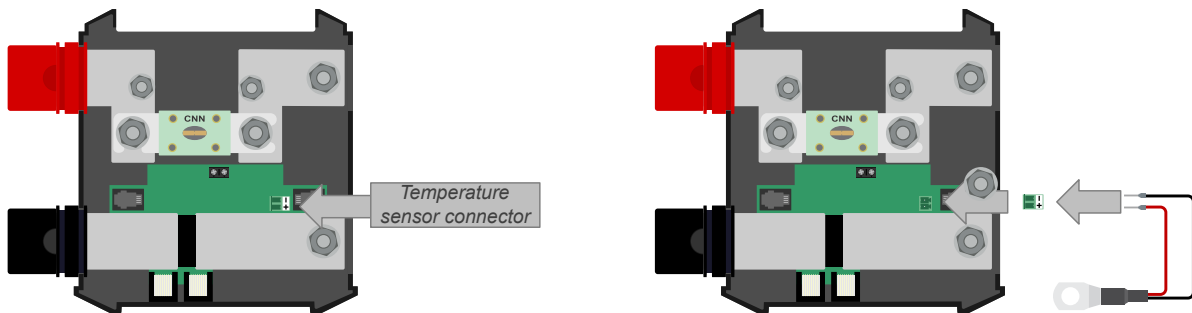

Temperature sensor connection Lynx Shunt VE.Can

### 6.2.4. Connect the alarm relay

The alarm relay connector is the black 2-way connector. See the below image for its location.

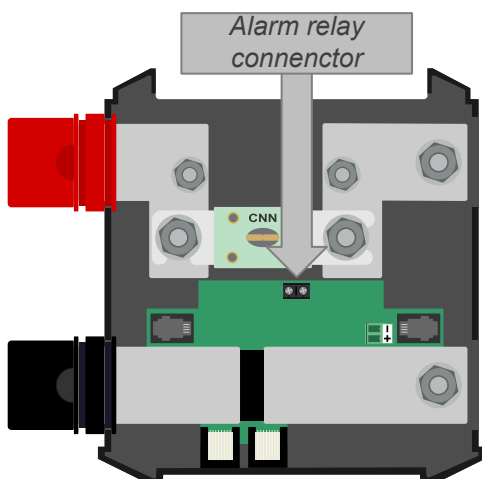

Alarm relay connection Lynx Shunt VE.Can

### 6.2.5. Place main fuse

Place the main fuse in the Lynx Shunt VE.can.

Be aware that if the positive bus is already powered, the moment the fuse is placed the system will become live.

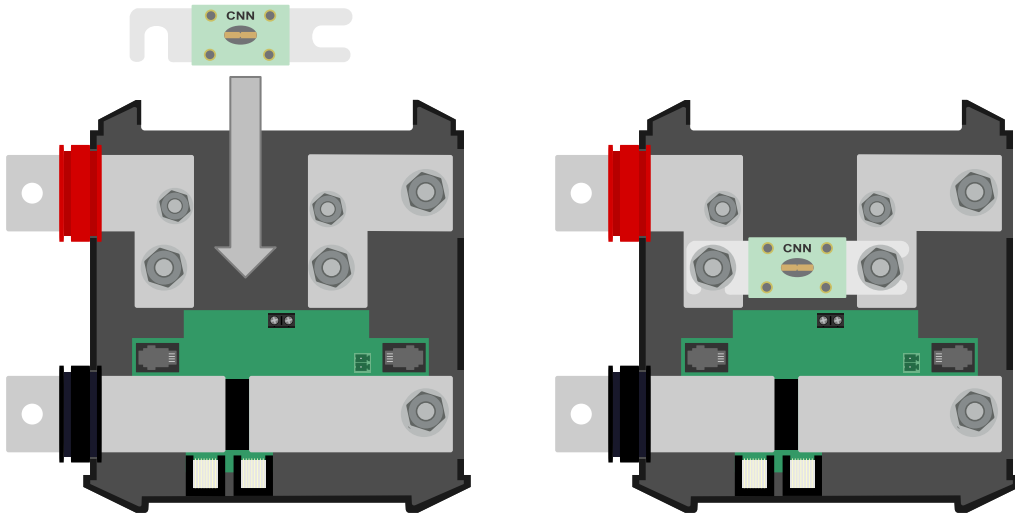

Placing the CNN fuse in the Lynx Shunt VE.Can

### 6.2.6. Connect the GX device

Connect the Lynx Shunt VE.Can (M8) VE.Can port to the GX device VE.Can port using a [RJ45 cable](#).

Multiple VE.Can devices can be interconnected, but make sure that the first and the last VE.Can devices both have a [VE.Can RJ45 terminator](#) installed.

Power the GX device from the output of the Lynx Shunt VE.Can or a Lynx distributor connected to the output of the Lynx Shunt VE.Can.

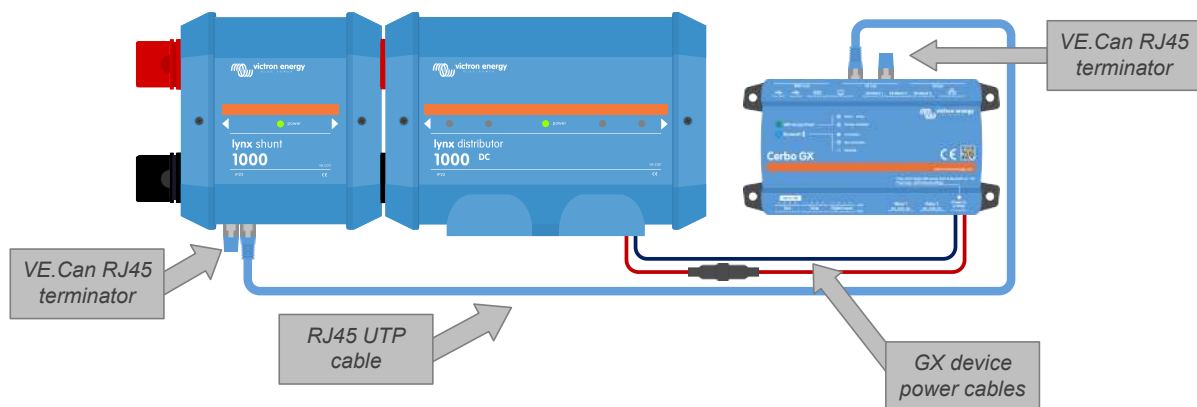

Wiring example Lynx Shunt VE.Can and GX device

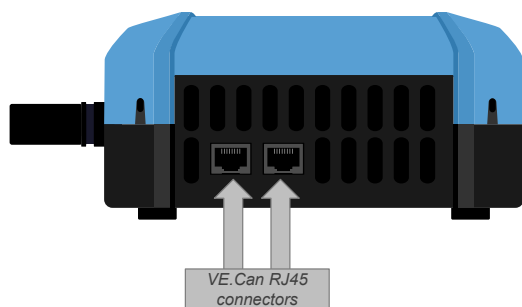

Location VE.Can connectors Lynx Shunt VE.Can

## 6.3. Configuration and settings

### 6.3.1. Settings Lynx Shunt VE.Can

Once powered up and connected to a GX device, navigate to the Lynx Shunt VE.Can settings menu on the GX device to make and change settings.

Most settings can be left to their default values, but there are a few essential settings to make on your own :

- Set the battery capacity.
- If lithium batteries are used, specific battery monitor settings are needed. Refer to the battery monitor settings chapter.
- If the alarm relay is used, set the alarm relay parameters.

For a full overview and an explanation of all battery monitor settings, refer to the battery monitor setting chapter

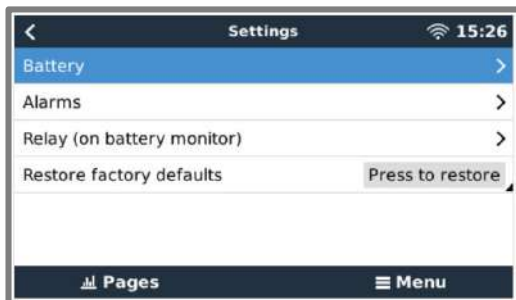

*Making Lynx Shunt VE.Can settings using a GX device*

## 7. Commissioning the Lynx Shunt VE.Can

Commissioning sequence:

- Check polarity of all DC cables.
- Check cross sectional area of all DC cables.
- Check if all cable lugs have been crimped correctly.
- Check if all cable connections are tight (don't exceed maximum torque).
- Tug slightly on each battery cable to check if the connections are tight and if the cable lugs have been crimped correctly.
- Turn a load on and see if the battery monitor displays the correct current polarity.
- Fully charge the battery, so that the battery monitor synchronises.

## 8. Operation Lynx Shunt VE.Can

The Lynx Shunt VE.Can is active as soon as power is applied to the input (battery side) of the Lynx Shunt VE.Can. The shunt monitors the state of charge of the battery and the fuse.

### LED indications

The basic Lynx Shunt VE.Can operation status is displayed via its power LED. See the below table for the information displayed via the Power LED.

**Table 1. Lynx Shunt VE.Can operational status**

Power LED	Description
Solid green	Lynx system is OK
Solid red	Main fuse is blown
Solid orange	An alarm is active
Blink red	Hardware failure
Blink red/green	Calibration error
Blink green fast	Initializing (bootloader)
Blink green slow	Firmware update
Blink orange	Firmware failure

### GX device indications

Operational data is displayed on the connected GX device. This includes data such as battery voltage, battery current, state of charge and so on.

See the below table of all monitored parameters.

**Table 2. Lynx Shunt VE.Can operational data**

Parameter	Description	Unit
Battery voltage	Displays the voltage of the battery	Volts
Battery current	Displays the current that flows into or out of the battery	Amps
Battery energy	Displays the power that flows into or out of the battery	Watt
State of charge	The state of charge indicates the percentage of the battery capacity that is still available for consumption. A full battery will show 100 %, and an empty battery will display 0 %. This is the best way to see when the batteries need to be recharged	Percentage
Consumed AmpHours	Displays the energy consumed since the battery was last fully charged	AmpHours
Time to go	Displays the estimated time, based on the current load, before the batteries need to be recharged	Hours and minutes
Relay state	Displays the state of the relay. On means that the relay contacts are closed, off means that the relay contacts are open	On/off
Alarm state	Displays if an alarm is active or not	Ok/Alarm
Battery temperature	Displays the battery temperature	Degrees Celsius
Firmware version	The Firmware version of this device	Number

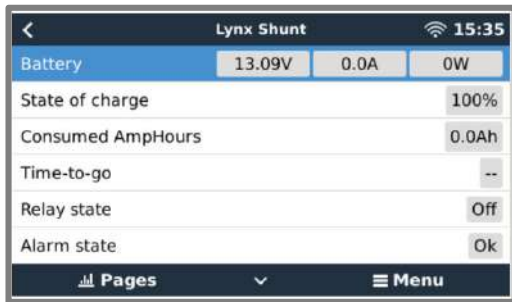

*GX device displaying Lynx Shunt VE.Can operational data*

### Historical data

The Lynx Shunt VE.Can keeps track of history data providing information about the state and the past use of the batteries. See the below table of all monitored parameters.

**Table 3. History data Lynx Shunt VE.Can**

Parameter	Description	Unit
Deepest discharge	The deepest discharge in Ah	AmpHour
Last discharge	The depth of the last discharge in Ah. This value will be reset to 0 when the State of Charge reaches 100 % again	AmpHour
Average discharge	The average discharge over all the cycles counted	AmpHour
Total charge cycles	Every time the battery is discharged below 65 % of its rated capacity and charged back to at least 90 %, one cycle is counted	Number
Number of full discharges	The number of times the battery has been discharged to a 0 % state of charge	Number
Cumulative Ah drawn	Records the total energy consumed over all charge cycles	AmpHour
Minimum voltage	Lowest voltage measured	Voltage
Maximum voltage	Highest voltage measured	Voltage
Time since last full charge	The time that has elapsed since the battery was last fully charged	Seconds
Synchronisation count	The number of times the Lynx Shunt has automatically synchronised	Number
Low voltage alarms	The number of times a low voltage alarm has occurred	Number
High voltage alarms	The number of times a high voltage alarm has occurred	Number
Clear history	Press to clear all history data	Press to clear

### Alarms and the alarm relay

In case of an alarm, a message is sent to the GX device and the VRM portal and/or the alarm relay is activated.

The alarm conditions are:

- Battery state of charge
- Battery voltage
- Battery temperature
- Main fuse blown

## 9. Battery monitor settings

This chapter explains all battery monitor settings. In addition to this we also have a video available explaining these settings and how the interact with each other to achieve accurate battery monitoring for both lead-acid and lithium batteries.



### 9.1. Battery capacity

This parameter is used to tell the battery monitor how big the battery is. This setting should already have been done during the initial installation.

The setting is the battery capacity in Amp-hours (Ah).

For more information on the battery capacity and the related Peukert exponent see the [Battery capacity and Peukert exponent \[23\]](#) chapter.

Setting	Default	Range	Step size
<b>Battery capacity</b>	200Ah	1 - 32500Ah	1Ah



The maximum battery capacity of 32500Ah is supported from firmware version v4.19 onwards; lower versions support a maximum of 9999Ah.

### 9.2. Charged voltage

The battery voltage must be above this voltage level to consider the battery as fully charged. As soon as the battery monitor detects that the voltage of the battery has reached this “charged voltage” parameter and the current has dropped below the “tail current [20]” parameter for a certain amount of time, the battery monitor will set the state of charge to 100%.

Setting	Default	Range	Step size
---------	---------	-------	-----------

The “charged voltage” parameter should be set to 0.2V or 0.3V below the float voltage of the charger.

The table below indicates the recommended settings for lead acid batteries.

Nominal battery voltage	Charged voltage setting
12V	13.2V
24V	26.4V
36V	39.6V
48V	52.8V

### 9.3. Tail current

The battery is considered as fully charged once the charge current has dropped to less than this “Tail current” parameter. The “Tail current” parameter is expressed as a percentage of the battery capacity.

Note that some battery chargers stop charging when the current drops below a set threshold. In these cases, the tail current must be set higher than this threshold.

As soon as the battery monitor detects that the voltage of the battery has reached the set “Charged voltage [20]” parameter and the current has dropped below this “Tail current” parameter for a certain amount of time, the battery monitor will set the state of charge to 100%.

Setting	Default	Range	Step size
<b>Tail current</b>	4.00%	0.50 - 10.00%	0.1%

## 9.4. Charged detection time

This is the time the “Charged voltage [20]” parameter and the “Tail current [20]” parameter must be met in order to consider the battery fully charged.

Setting	Default setting	Range	Step size
Charged detection time	3 minutes	0 - 100 minutes	1 minute

## 9.5. Peukert exponent

Set the Peukert exponent parameter according to the battery specification sheet. If the Peukert exponent is unknown, set it at 1.25 for lead-acid batteries and set it at 1.05 for lithium batteries. A value of 1.00 disables the Peukert compensation. The Peukert value for lead-acid batteries can be calculated. For more information on the Peukert calculation, the Peukert exponent and how this relates to the battery capacity, see the [Battery capacity and Peukert exponent \[23\]](#) chapter.

Setting	Default	Range	Step size
Peukert exponent	1.25	1.00 - 1.50	0.01

## 9.6. Charge efficiency factor

The “Charge Efficiency Factor” compensates for the capacity (Ah) losses during charging. A setting of 100% means that there are no losses.

A charge efficiency of 95% means that 10Ah must be transferred to the battery to get 9.5Ah actually stored in the battery. The charge efficiency of a battery depends on battery type, age and usage. The battery monitor takes this phenomenon into account with the charge efficiency factor.

The charge efficiency of a lead acid battery is almost 100% as long as no gas generation takes place. Gassing means that part of the charge current is not transformed into chemical energy, which is stored in the plates of the battery, but is used to decompose water into oxygen and hydrogen gas (highly explosive!). The energy stored in the plates can be retrieved during the next discharge, whereas the energy used to decompose water is lost. Gassing can easily be observed in flooded batteries. Please note that the ‘oxygen only’ end of the charge phase of sealed (VRLA) gel and AGM batteries also results in a reduced charge efficiency.

Setting	Default setting	Range	Step size
Charge efficiency factor	95%	50 - 100%	1%

## 9.7. Current threshold

When the current measured falls below the “Current threshold” parameter it will be considered zero. The “Current threshold” is used to cancel out very small currents that can negatively affect the long-term state of charge readout in noisy environments. For example, if the actual long-term current is 0.0A and, due to injected noise or small offsets, the battery monitor measures 0.05A the battery monitor might, in the long term, incorrectly indicate that the battery is empty or will need to be recharged. When the current threshold in this example is set to 0.1A, the battery monitor calculates with 0.0A so that errors are eliminated.

A value of 0.0A disables this function.

Setting	Default	Range	Step size
Current threshold	0.10A	0.00 - 2.00A	0.01A

## 9.8. Time-to-go averaging period

The time-to-go averaging period specifies the time window (in minutes) that the moving averaging filter works. A value of 0 (zero) disables the filter and gives an instantaneous (real-time) readout. However, the displayed “Time remaining” value may fluctuate heavily. Selecting the longest time, 12 minutes, will ensure that only long-term load fluctuations are included in the “Time remaining” calculations.

Setting	Default	Range	Step size
Time-to-go averaging period	3 minutes	0 - 12 minutes	1 minute

## 9.9. Synchronise SoC to 100%

This option can be used to manually synchronise the battery monitor.

In the VictronConnect app press the “Synchronise” button to synchronise the battery monitor to 100%.

## 9.10. Zero current calibration

This option can be used to calibrate the zero reading if the battery monitor reads a non-zero current even when there is no load and the battery is not being charged.

A zero current calibration is (almost) never needed. Only perform this procedure in case the battery monitor shows a current while you are absolutely sure that there is no actual current flowing. The only way to be sure is to physically disconnect all wires and cables connected to the side of the shunt. Do this by unscrewing the shunt bolt and removing all cables and wires from that side of the shunt. The alternative, switching loads or chargers off, is NOT accurate enough as this does not eliminate small standby currents.

## 10. Battery capacity and Peukert exponent

Battery capacity is expressed in Amp hour (Ah) and indicates how much current a battery can supply over time. For example, if a 100Ah battery is being discharged with a constant current of 5A, the battery will be totally discharged in 20 hours.

The rate at which a battery is being discharged is expressed as the C rating. The C rating indicates how many hours a battery with a given capacity will last. 1C is the 1h rate and means that the discharge current will discharge the entire battery in 1 hour. For a battery with a capacity of 100Ah, this equates to a discharge current of 100A. A 5C rate for this battery would be 500A for 12 minutes (1/5 hours), and a C5 rate would be 20A for 5 hours.



There are two ways of expressing the C rating of a battery. Either with a number before the C or with a number after the C.

For example:

- 5C is the same as C0.2
- 1C is the same as C1
- 0.2C is the same as C5

The capacity of a battery depends on the rate of discharge. The faster the rate of discharge, the less capacity will be available. The relation between slow or fast discharge can be calculated by Peukert's law and is expressed by the Peukert exponent. Some battery chemistries suffer more from this phenomenon than others. Lead acid are more affected by this than lithium batteries are. The battery monitor takes this phenomenon into account with Peukert exponent.

### Discharge rate example

A lead acid battery is rated at 100Ah at C20, this means that this battery can deliver a total current of 100A over 20 hours at a rate of 5A per hour.  $C20 = 100Ah (5 \times 20 = 100)$ .

When the same 100Ah battery is discharged completely in two hours, its capacity is greatly reduced. Because of the higher rate of discharge, it may only give  $C2 = 56Ah$ .

### Peukert's formula

The value which can be adjusted in Peukert's formula is the exponent n: see the formula below.

In the battery monitor the Peukert exponent can be adjusted from 1.00 to 1.50. The higher the Peukert exponent the faster the effective capacity 'shrinks' with increasing discharge rate. An ideal (theoretical) battery has a Peukert exponent of 1.00 and has a fixed capacity regardless of the size of the discharge current. The default setting in the battery monitor for the Peukert exponent is 1.25. This is an acceptable average value for most lead acid batteries.

Peukert's equation is stated below:

$C_p = I^n \times t$  Where Peukert's exponent n is:

$$n = \frac{\log t_2 - \log t_1}{\log I_1 - \log I_2}$$

To calculate the Peukert exponent you will need two rated battery capacities. This is usually the 20h discharge rate and the 5h rate, but can also be the 10h and 5h, or the 20h and the 10h rate. Ideally use a low discharge rating together with a substantially higher rating. Battery capacity ratings can be found in the battery datasheet. If in doubt contact your battery supplier.

**Calculation example using the 5h and the 20h rating**

The C5 rating is 75Ah. The t1 rating is 5h and I1 is calculated:

$$I_1 = \frac{75Ah}{5h} = 15A$$

The C20 rating is 100Ah. The t2 rating is 20h and I2 is calculated:

$$I_2 = \frac{100Ah}{20h} = 5A$$

The Peukert exponent is:

$$n = \frac{\log 20 - \log 5}{\log 15 - \log 5} = 1.26$$

A Peukert calculator is available at <http://www.victronenergy.com/support-and-downloads/software#peukert-calculator>.

Please note that the Peukert exponent is no more than a rough approximation of reality. In case of very high currents, the battery will give even less capacity than predicted by a fixed exponent. We do not recommend changing the default value in the battery monitor, except in the case of lithium batteries.

## 11. Troubleshooting and Support

For unexpected behaviour or suspected product faults, refer to this chapter.

Start by checking the common issues described here. If the problem persists, contact the point of purchase (Victron dealer or distributor) for technical support.

If you're unsure who to contact or if the point of purchase is unknown, refer to the [Victron Energy Support webpage](#).

### 11.1. Cabling issues

#### Cables heat up

This can be caused by a wiring or connection issue. Check the following:

- Check if all cable connections are tightened with a torque moment of 14Nm (17Nm for the M10 model).
- Check if all fuse connections are tightened with a torque moment of 14Nm (17Nm for the M10 model).
- Check if the surface area of the cable core is large enough for the current through that cable.
- Check if all cable lugs have been crimped correctly and are tight enough.

#### Other cabling issues

For additional information about issues that can arise from bad or incorrect cabling, cable connections or wiring of battery banks refer to the [Wiring Unlimited Book](#).

### 11.2. Main fuse issues

For additional information about issues that can arise from an incorrect fuse rating or type refer to the [Wiring Unlimited Book](#).

#### The fuse blows as soon as a new fuse is installed

Check the DC circuit that is attached to the fuse for the following:

Check if there is a short circuit.

Check if there is a malfunctioning load.

Check if the current in the circuit is not larger than the fuse rating.

### 11.3. Battery monitor issues

#### 11.3.1. Charge and discharge current are inverted

The charge current should be shown as a positive value. For example: 1.45A.

The discharge current should be shown as a negative value. For example: -1.45A.

If the charge and discharge currents are reversed, the negative power cables on the battery monitor must be swapped.

#### 11.3.2. Incomplete current reading

The negatives of all the loads and the charge sources in the system must be connected to the system minus side of the shunt.

If the negative of a load or a charge source is connected directly to the negative battery terminal or the "battery minus" side on the shunt, their current will not flow through the battery monitor and will be excluded from the overall current reading and the state of charge reading.

The battery monitor will display a higher state of charge than the actual state of charge of the battery.

#### 11.3.3. There is a current reading while no current flows

If there is a current reading while no current is flowing through the battery monitor, perform a [zero current calibration \[22\]](#) while all loads are turned off or set the [current threshold \[21\]](#).

### 11.3.4. Incorrect state of charge reading

An incorrect state of charge can be caused by a variety of reasons.

#### Incorrect battery settings

The following parameter(s) will have an effect on the state of charge calculations if they have been set up incorrectly:

- Battery capacity.
- Peukert exponent.
- Charge efficiency factor.

#### Incorrect state of charge due to a synchronisation issue:

The state of charge is a calculated value and will need to be reset (synchronised) every now and then.

The synchronisation process is automatic and is performed each time the battery is fully charged. The battery monitor determines that the battery is fully charged when all 3 "charged" conditions have been met. The "charged" conditions are:

- Charged voltage (Voltage).
- Tail current (% of battery capacity).
- Charge detection time (minutes).

A practical example of the conditions that need to be met before a synchronisation will take place:

- The battery voltage has to be above 13.8V.
- The charge current has to be less than  $0.04 \times$  battery capacity (Ah). For a 200Ah battery, this is  $0.04 \times 200 = 8A$ .
- Both above conditions have to be stable for 3 minutes.

If the battery is not fully charged or if the automatic synchronisation does not happen, the state of charge value will start to drift and will eventually not represent the actual state of charge of the battery.

The following parameter(s) will have an effect on automatic synchronisation if they have been set incorrectly:

- Charged voltage.
- Tail current.
- Charged detection time.
- Not occasionally fully charging the battery.

For more information on these parameters see the chapter: "Battery settings".

#### Incorrect state of charge due to incorrect current reading:

The state of charge is calculated by looking at how much current flows in and out of the battery. If the current reading is incorrect, the state of charge will also be incorrect. See paragraph [Incomplete current reading \[25\]](#).

### 11.3.5. State of charge always shows 100%

One reason could be that the negative cables going in and out of the battery monitor have been wired the wrong way around, see [Charge and discharge current are inverted \[25\]](#).

### 11.3.6. State of charge does not reach 100%

The battery monitor will automatically synchronise and reset the state of charge to 100% as soon as the battery has been fully charged. In case the battery monitor does not reach a 100% state of charge, do the following:

- Fully charge the battery and check if the battery monitor correctly detects if the battery is fully charged.
- If the battery monitor does not detect that the battery has been fully charged you will need to check or adjust the charged voltage, tail current and/or charged time settings. For more information see [Automatic synchronisation](#).

### 11.3.7. State of charge does not increase fast enough or too fast when charging

This can happen when the battery monitor thinks the battery is bigger or smaller than in reality. Check if the [battery capacity](#) has been set correctly.

### 11.3.8. State of charge is missing

This means that the battery monitor is in an unsynchronised state. This can occur when the battery monitor has just been installed or after it has been unpowered for some time and is being powered up again.

To fix this, fully charge the battery. Once the battery is close to a full charge, the battery monitor should synchronise automatically. If that doesn't work, review the synchronisation settings.

### 11.3.9. Synchronisation issues

If the battery monitor does not synchronise automatically, one possibility could be that the battery never reaches a fully charged state. Fully charge the battery and see if the state of charge eventually indicates 100%.

Another possibility is that the [charged voltage setting \[20\]](#) should be lowered and/or the [tail current setting \[20\]](#) should be increased.

It is also possible that the battery monitor synchronises too early. This can happen in solar systems or in systems that have fluctuating charge currents. If this is the case change the following settings:

- Increase the "[charged voltage \[20\]](#)" to slightly below the absorption charge voltage. For example: 14.2V in case of 14.4V absorption voltage (for a 12V battery).
- Increase the "[charged detection time \[21\]](#)" and/or decrease the "[tail current \[20\]](#)" to prevent an early reset due to passing clouds.

## 11.4. GX device issues

This chapter only describes the most common issues. If this chapter does not solve your issue, consult the manual of the GX device.

### Incorrect CAN-bus profile selected

Check that VE.Can is set to use the correct CAN-bus profile. In the Remote Console, navigate to Settings → Services → VE.Can port and check if it is set to "VE.Can and Lynx Smart BMS 250kb".

### RJ45 terminator or cable issue

VE.Can devices connect in a daisy chain to each other and a [RJ45 terminator](#) needs to be used with the first and last device in the chain.

When connecting a VE.Can device, always use "manufactured" [RJ45 UTP cables](#). Do not manufacture these cables yourself. Many communication and other seemingly unrelated product issues are caused by faulty homemade cables.

## 12. Technical specifications Lynx Shunt VE.Can (M8)

Power	
Supply voltage range	9 - 70 Vdc
Supported system voltages	12, 24 or 48 V
Reverse polarity protection	No
Current rating	1000 Adc continuous
Power consumption	60 mA @ 12 V 33 mA @ 24 V 20 mA @ 48 V
Potential free alarm contact	3 A, 30 Vdc, 250 Vac

Connections	
Busbar	M8
Fuse	M8 (a Mega fuse can be installed on the M6 bolts)
VE.Can	RJ45 and RJ45 terminator
Power supply connection to Lynx Distributor	RJ10 (a RJ10 cable ships with each Lynx Distributor)
Temperature sensor	Terminal connector (Sensor included)
Relay	Screw terminal

Physical	
Enclosure material	ABS
Enclosure dimensions (hwxwd)	190 x 180 x 80mm
Unit weight	1.4 kg
Busbar material	Tinned copper
Busbar dimensions (hwx)	8 x 30mm

Environmental	
Operating temperature range	-40 °C to +60 °C
Storage temperature range	-40 °C to +60 °C
Humidity	Max. 95 % (non-condensing)
Protection class	IP22

## 13. Enclosure dimensions Lynx Shunt VE.Can

